

INSTALLATION GUIDE

BEFORE YOU START



- To ensure that the installation and erection of your Stratco Handi-Mate™ Shed proceeds smoothly you should confirm that all the components and materials listed on the delivery documentation and in this installation guide have been supplied. Details for ordering individual components can be found in the "Component Index" section at the end of this document.
- Carefully read this installation guide to familiarise yourself with all the steps involved and ensure that you have the correct tools and equipment for the job.
- There are different types and colours of screws. Ensure that the right type and colour screw is being used at each location.
- Use heavy gloves when handling steel sheeting and flashings and never attempt to install a shed in windy conditions.
- It is important that you contact your local government authority to determine if building approval is required.
- Stability and performance of the shed relies on the door being closed during high wind events.
- It is essential to clear and level the site prior to assembling your Stratco Handi-Mate™ Shed.
- Do not traverse the roof of the Handi-Mate™.
- The installer is responsible for ensuring the wall, slab or concrete pads are sufficient to support the shed and sustain wind loading. Do not directly anchor your shed to pavers. All Stratco Handi-Mate™ Off the Wall Sheds must be securely bolted to a permanent concrete base and brick or concrete wall with sufficient masonry anchors as specified in Figure 7.6 to prevent wind uplift.
 - Option 1 - Before building the shed, pour a base that is larger than the area by at least 200mm in each direction. The base should be poured so the concrete outside the shed floor area slopes away from the shed to help prevent water from entering the shed.
 - Option 2 - Substantial concrete pads may be used at each anchor location as an alternative to a complete concrete floor. It is recommended pads are minimum Ø250mm x 400mm deep, embedded into a firm natural soil base.
- Where necessary, components are marked with a coloured sticker as to easily differentiate one from another. Components are referenced throughout the installation guide by their colour. For example, Bottom Channel is marked with a red ● sticker.

HANDI-MATE™ OFF THE WALL HM3 SLIDING DOOR SHED

HANDI-MATE™ OFF THE WALL HM3 SLIDING DOOR SHED INSTALLATION GUIDE

HANDI-MATE™ OFF THE WALL HM3 SLIDING DOOR SHED INSTALLATION GUIDE

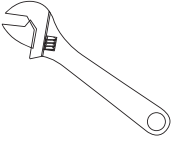
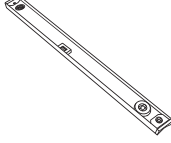
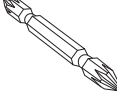
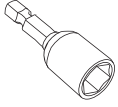
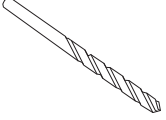

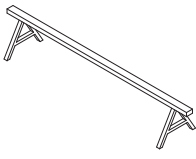
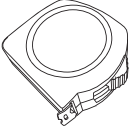



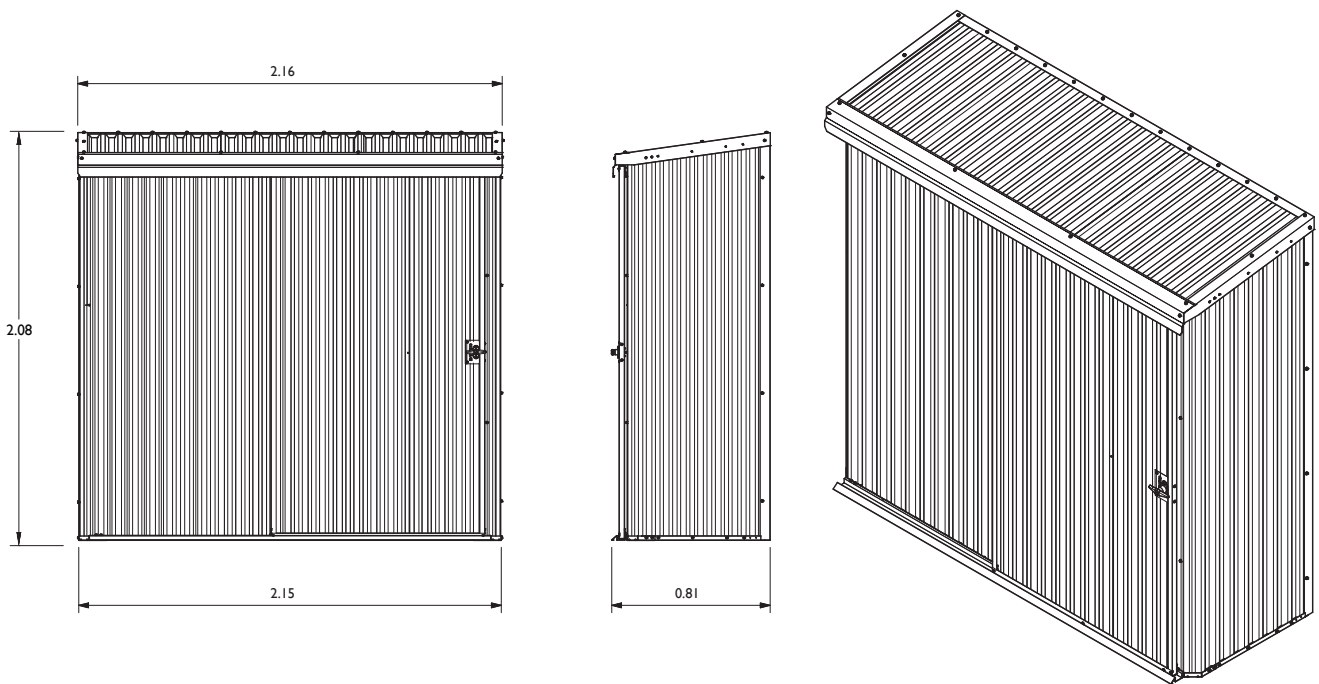









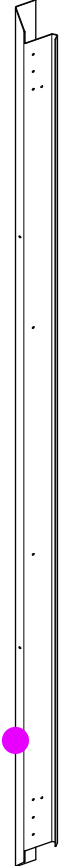

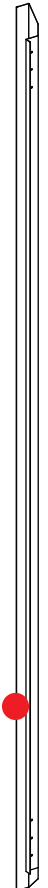



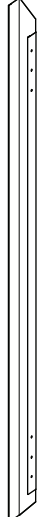

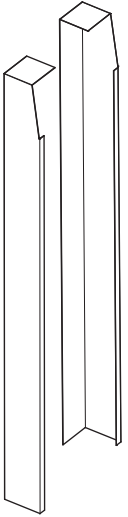

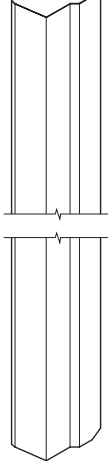
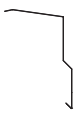
TOOLS REQUIRED

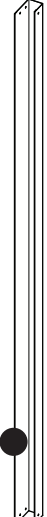
Rivet Gun 	Power Drill 	Adjustable Spanner 	Spirit Level 	PH2 Phillips Head Bit (Supplied) 	5/16 - 8mm Hex Head Bit (Supplied) 	3.5mm Bit (Supplied) 12mm Bit 10mm Masonry Bit 
Caulking Gun & Silicone 	Gloves 	Safety Glasses 	Step Ladder 	2 x Trestles 	Tape Measure 	

HANDI-MATE™ DIMENSIONS









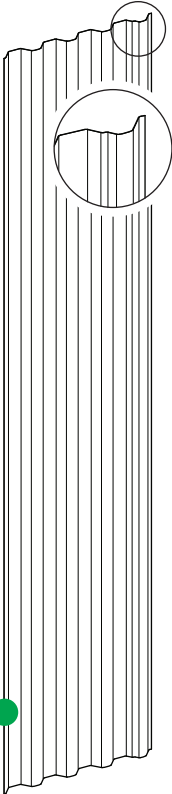
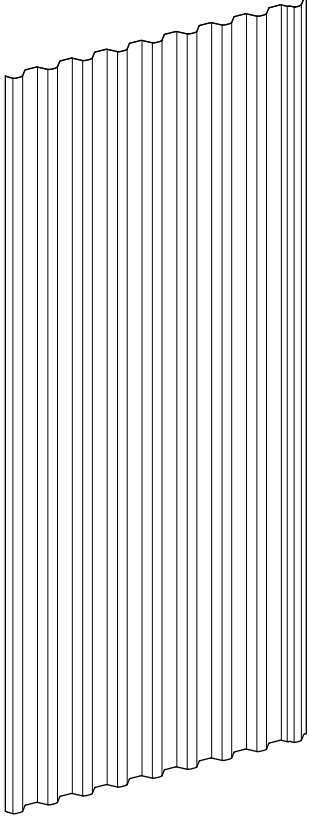
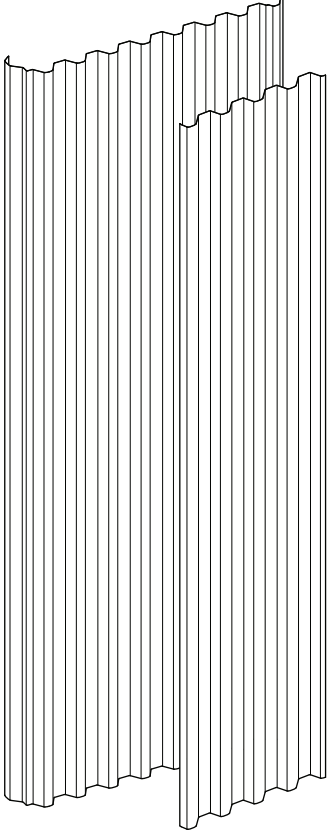
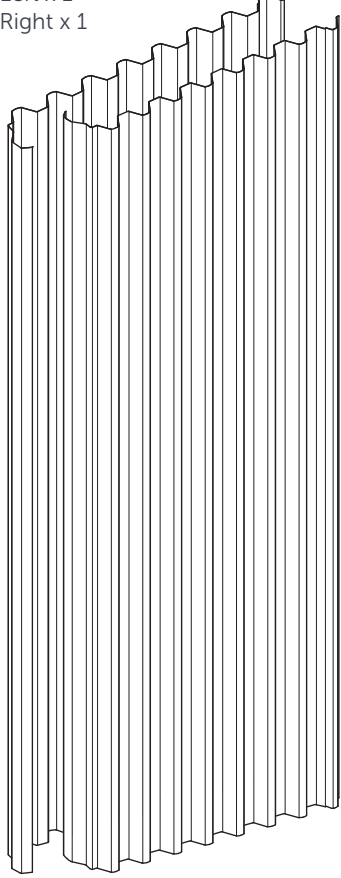

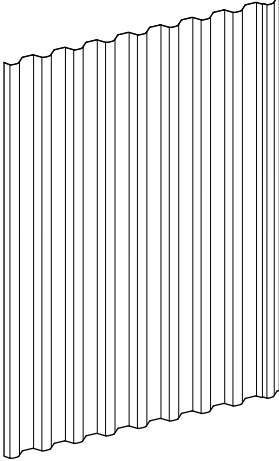



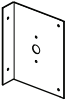
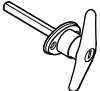

COMPONENTS

<p>Wall Mount Channel x 2</p>  	<p>Roof Mount Channel x 1</p>  	<p>Gutter x 1</p>  	<p>Sliding Rail x 1</p>  	<p>Bottom Channel x 1</p>  	<p>Runner Rail x 1</p>  	<p>Wall Channel x 4</p>  
<p>Left Barge Cap x 1 Right Barge Cap x 1</p>  	<p>Front Barge Cap x 1</p>  	<p>Top Door Channel x 1</p>  	<p>Bottom Door Channel x 1</p>  	<p>Door Shroud x 1</p>  	<p>Vertical Door Channel x 2</p>  	<p>Door Jamb x 2</p>  

COMPONENTS

<p>Split Door Sheet x 1</p> 	<p>Door Sheet x 1</p> 	<p>Corner Wall Sheet x 1 Split Wall Sheet x 1</p> 	<p>Side Wall Sheet Left x 1 Right x 1</p> 
--	--	---	--

<p>Roof Sheet Full x 3</p> 	<p>Door Wheel x2</p> 	<p>Door Nut x2</p> 	<p>Door Stop x1</p> 	<p>Corner Bracket x4</p> 	<p>Handle Mount x2</p> 
	<p>Door Handle x 1</p> 	<p>Door Tongue x 1</p> 	<p>Door Latch x 1</p> 	<p>Hold Down Lug x 1</p> 	<p>Coloured Rivet x 3</p> 
	<p>M8x47 Masonry Anchor x 12</p> 	<p>10x16 Wafer-Head Screw x 26</p> 	<p>10x22 Wafer-Head Screw x 1</p> 	<p>10x16 Hex-Head Screw x 62</p> 	
	<p>Coloured 10x16 Hex-Head Screw (with neo washer) x 47</p> 				

ASSEMBLY HANDY HINTS

The 'Sheet Crest', as referenced throughout this guide, refers to the curved top faces of the sheet (Figure 1.0).

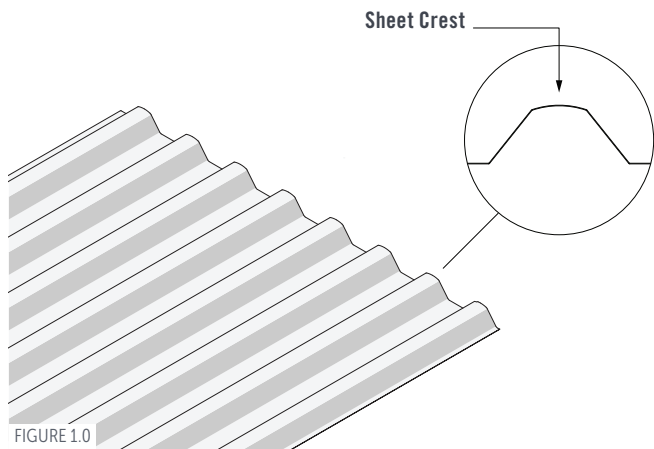

FIGURE 1.0

When assembling the Wall and Door Sheets, lay the sheets down on trestles/blocks (Figure 1.1). This will make assembly easier and reduce the risk of damage to components.

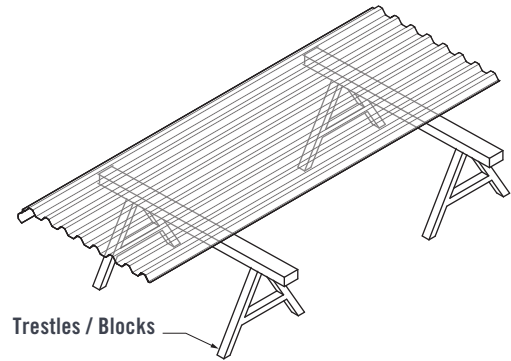

FIGURE 1.1

(Optional) Drainage holes can be drilled to help trapped water flow out of the bottom Wall Channels. After assembling the Walls, drill 6mm holes spaced approximately 350mm apart through the bottom Wall Channels of each Wall. Ensure holes are located in-between Sheet crests. Ensure metal filings are removed from the channels as to prevent rust spots from forming (Figure 1.2).

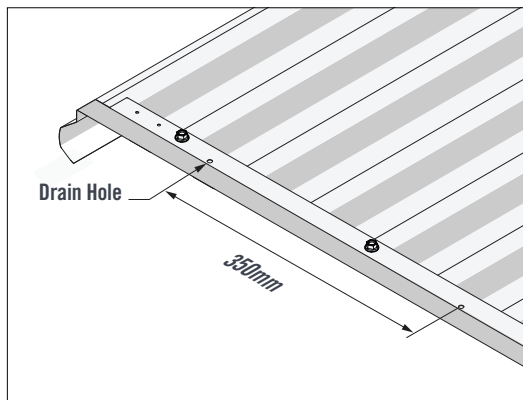
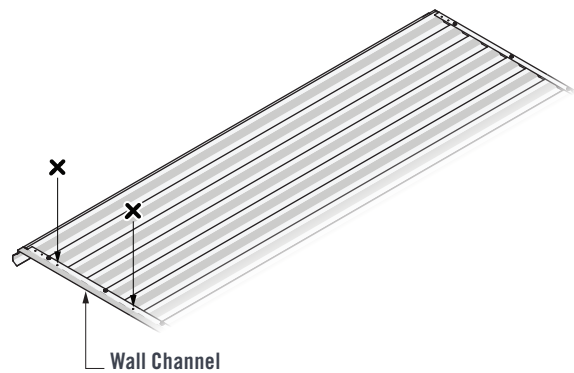

FIGURE 1.2



RIGHT SIDE WALL ASSEMBLY

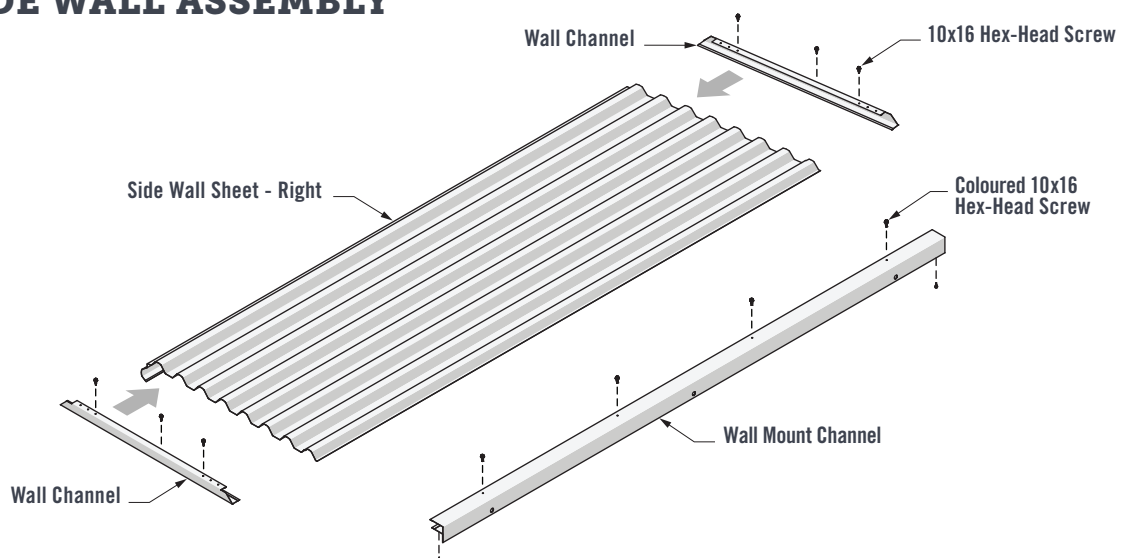
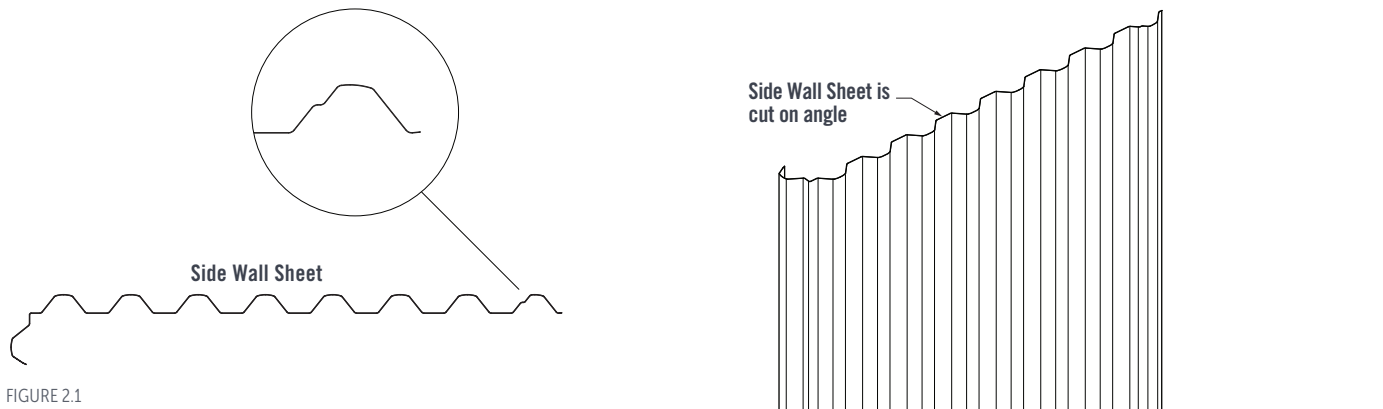

FIGURE 2.0

HANDI-MATE™ OFF THE WALL HM3 SLIDING DOOR SHED INSTALLATION GUIDE

Using Trestles or Blocks to support the Sheets, lay the Corner Wall Sheet down. Note: the top of the Side Wall Sheets are cut on an angle (Figure 2.1).



1. Fit the Wall Channels over the Side Wall Sheet (Right). The end of the Wall Channel should fit up against the end of the Corner Wall Sheet (Figure 2.2).

2. Fasten through the third pilot hole of both Wall Channel ends and into the Wall Sheet crests. Fasten through the Wall Channels and into the third Wall Sheet crest using one 10x16 Hex-Head Screw in each Wall Channel (Figure 2.2).

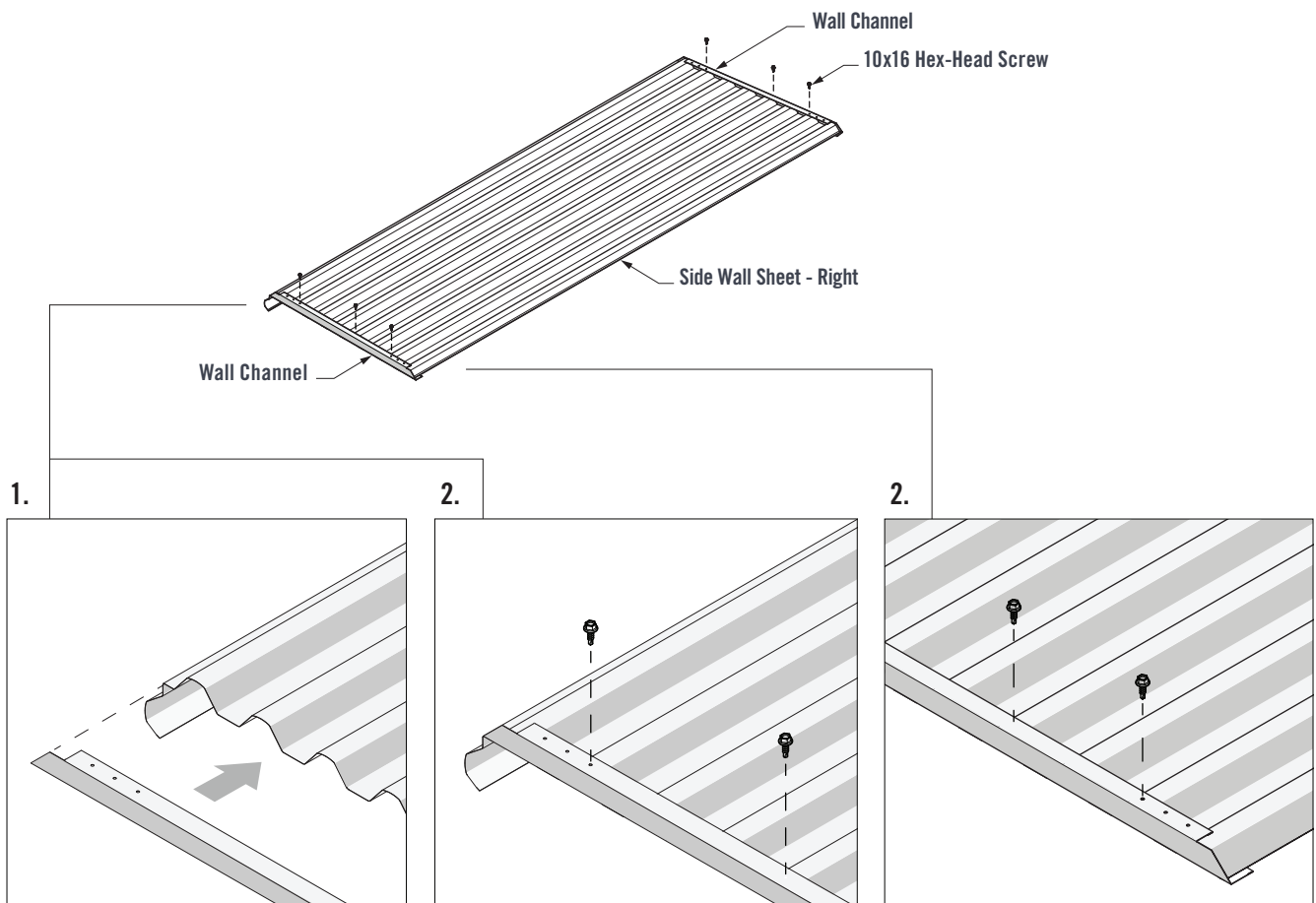

1. Fit the Wall Mount Channel over the Side Wall Sheet (Right). The end of the Wall Mount Channel should fit up against the end of the Wall Channel (Figure 2.3).

2. Fasten six Coloured 10x16 Hex-Head Screws through the pilot holes of the Wall Mount Channel and into the Side Wall Sheet (Right) and Wall Channels (Figure 2.3).

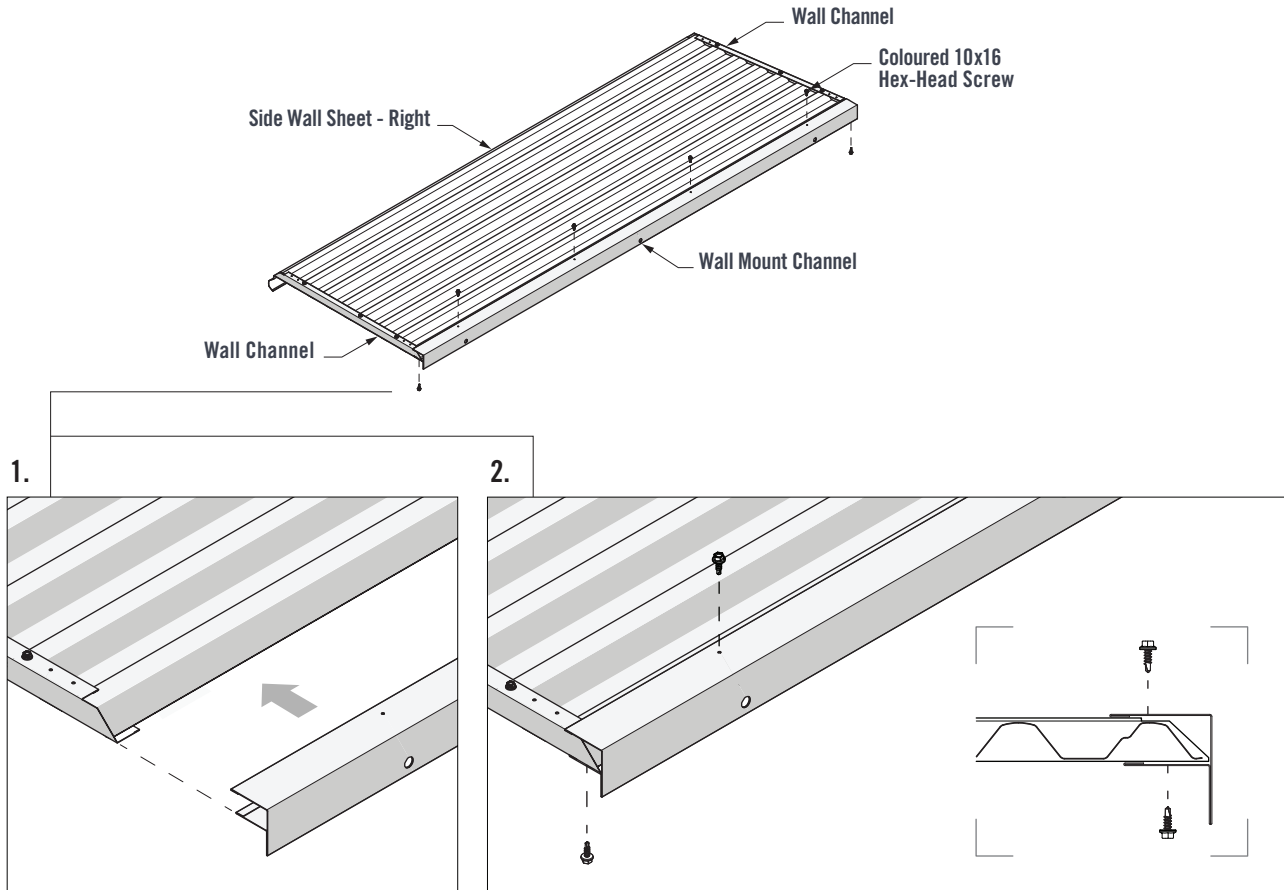

FIGURE 2.3

LEFT SIDE WALL ASSEMBLY

Repeat steps in Figures 2.0 - 2.3 to make a Left Side Wall Assembly.

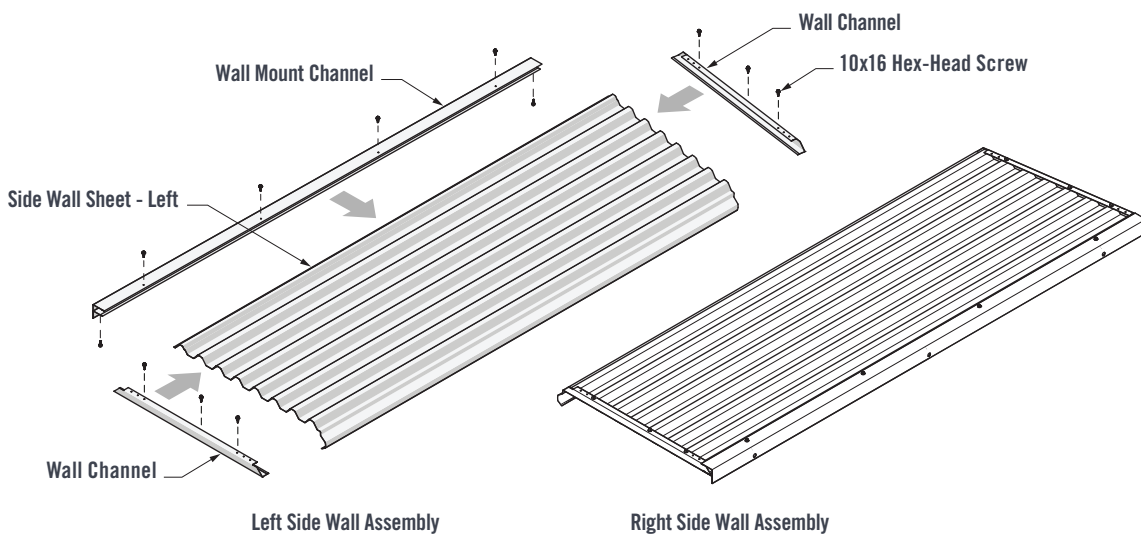

FIGURE 3.0

FRONT WALL ASSEMBLY

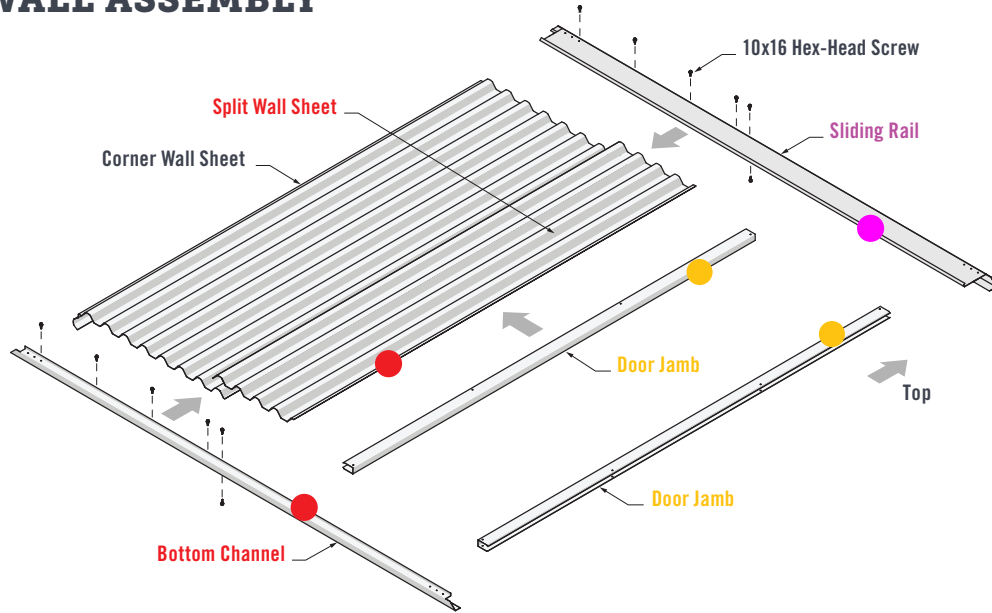

FIGURE 4.0

Using Trestles or Blocks to support the Sheets, lay down the **Corner Wall Sheet** and **Split Wall Sheet** (Figure 4.1).

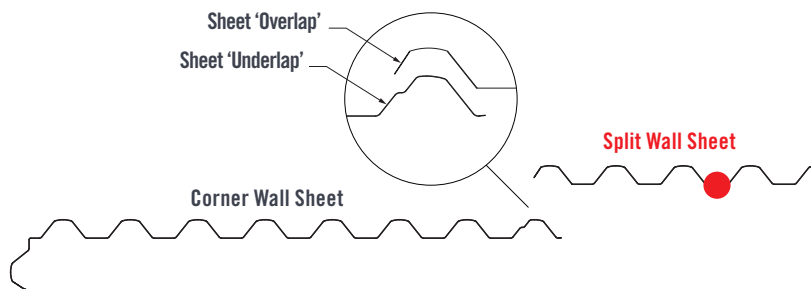

FIGURE 4.1

1. Fit the **Bottom Channel** and **Sliding Rail** over the **Corner Wall Sheet**. The end of the **Bottom Channel** and **Sliding Rail** should fit up against the ends of the **Corner Wall Sheet** (Figure 4.2).

2. Fasten one **10x16 Hex-Head Screw** through the third pilot hole of the **Bottom Channel** and **Sliding Rail** and into the **Corner Wall Sheet** crest. Fasten three **10x16 Hex-Head Screw** through the **Bottom Channel** and **Sliding Rail** and into every third **Corner Wall Sheet** crest (Figure 4.2).

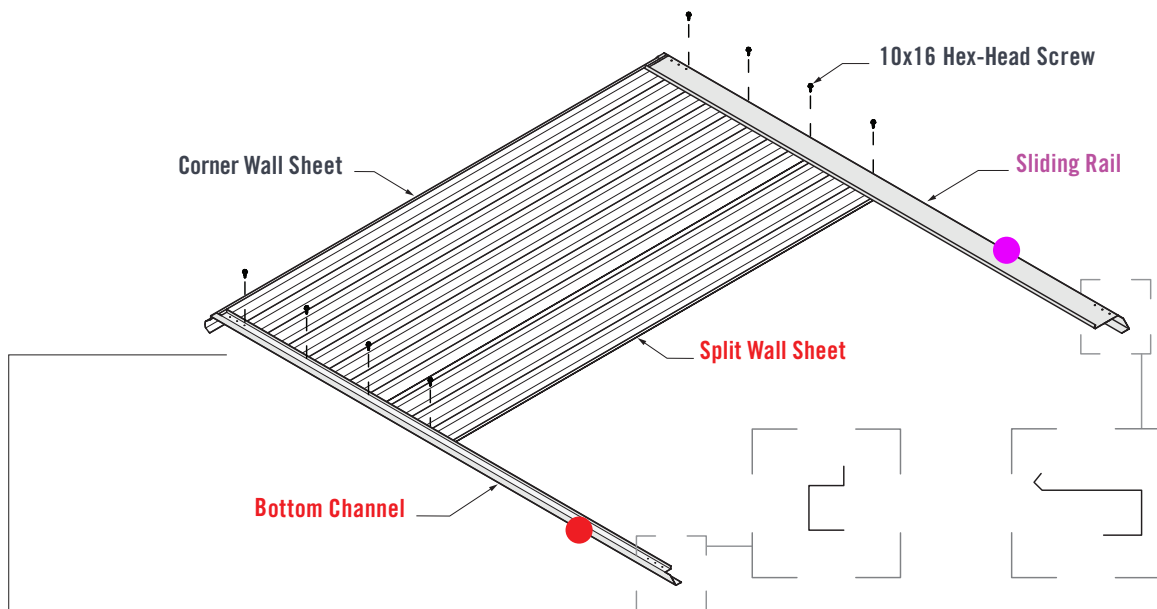

FIGURE 4.2

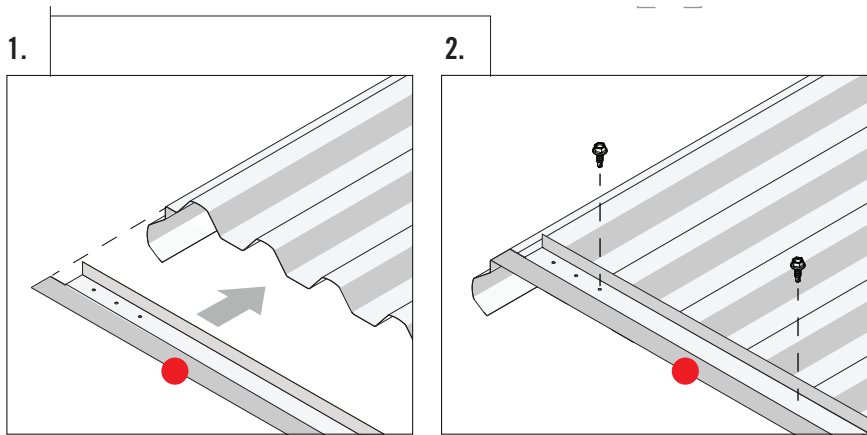

FIGURE 4.2

1. Fit the **Door Jamb** over the Corner Wall Sheet, ensuring it is inside the **Bottom Channel** and **Sliding Rail** (Figure 4.3).
2. Fasten two 10x16 Hex-Head Screws through the pilot holes of the **Sliding Rail** and into the **Door Jamb**. Fasten two 10x16 Hex-Head Screws through the **Bottom Channel** and into the **Door Jamb** (Figure 4.3).

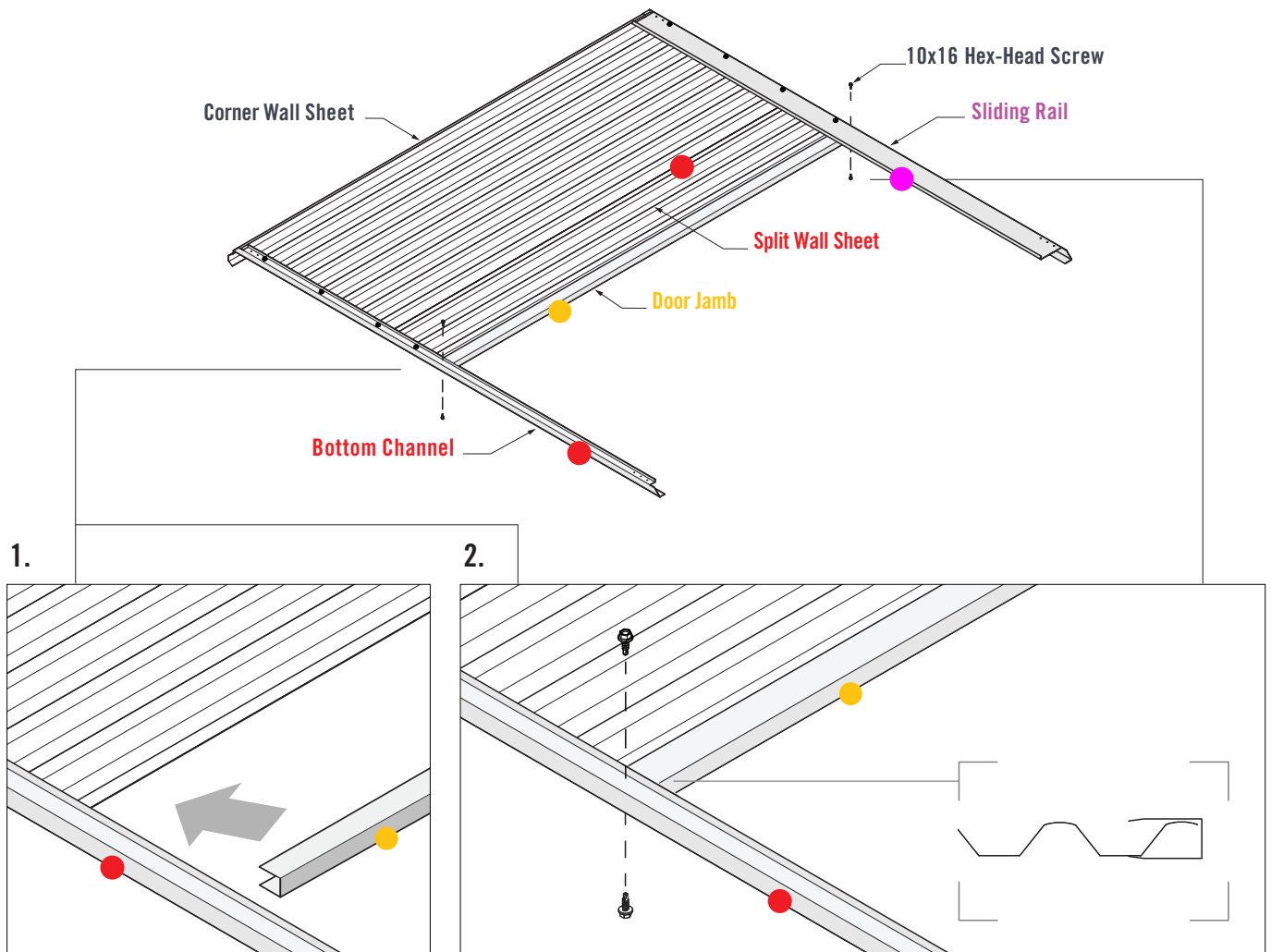

FIGURE 4.3

HANDI-MATE™ OFF THE WALL HM3 SLIDING DOOR SHED INSTALLATION GUIDE

Slide the other **Door Jamb** approximately 150mm into the **Bottom Channel** and **Sliding Rail**. Ensure the open end of the **Door Jamb** is facing away from the sheets (Figure 4.4).

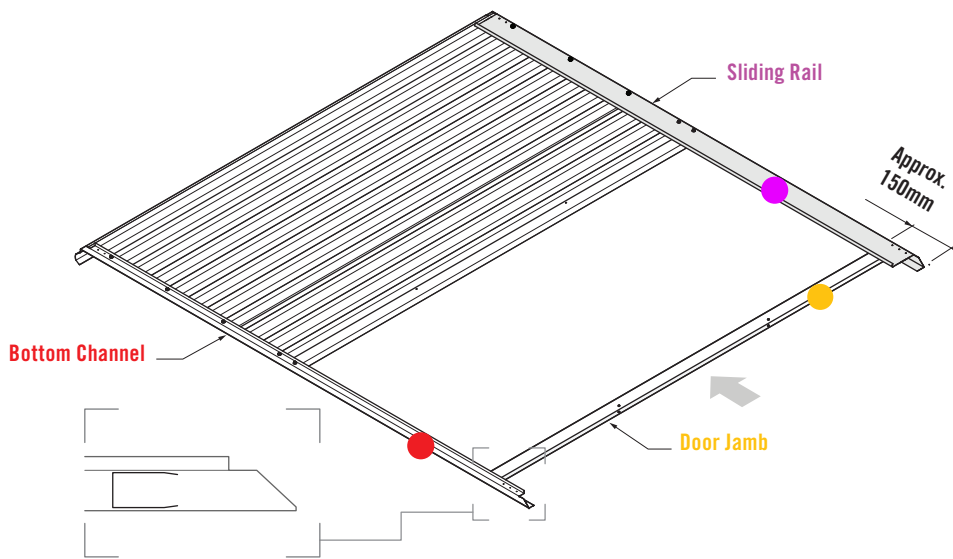

FIGURE 4.4

DOOR ASSEMBLY

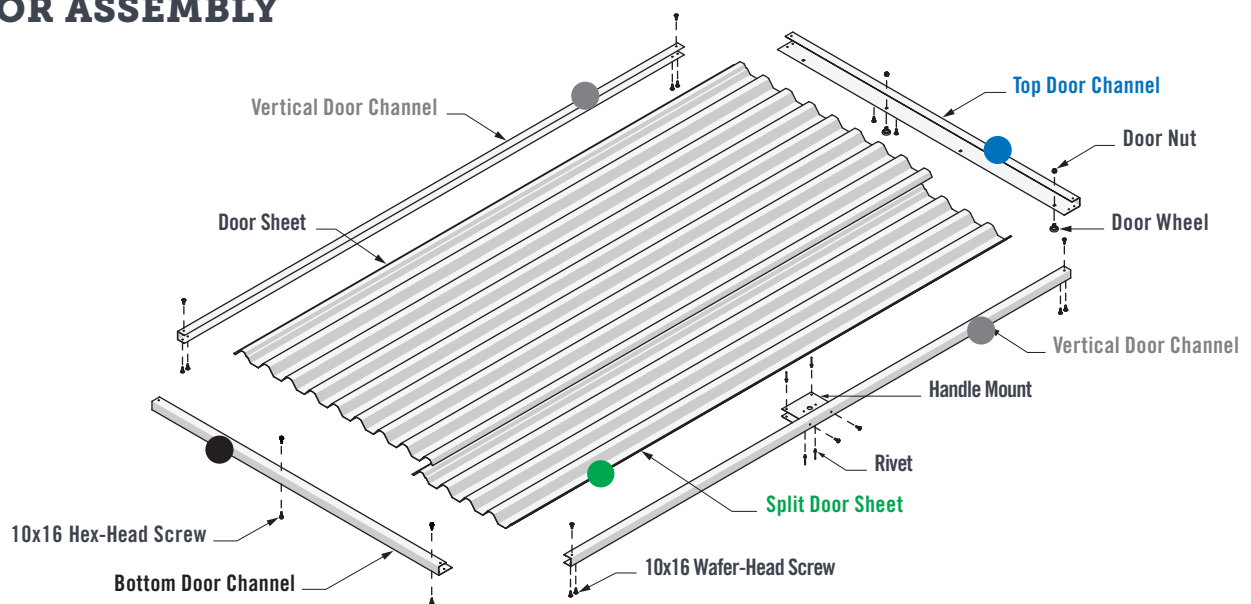

FIGURE 5.0

Fix the two Door Wheels to the **Top Door Channel** using Door Nuts (Figure 5.1).

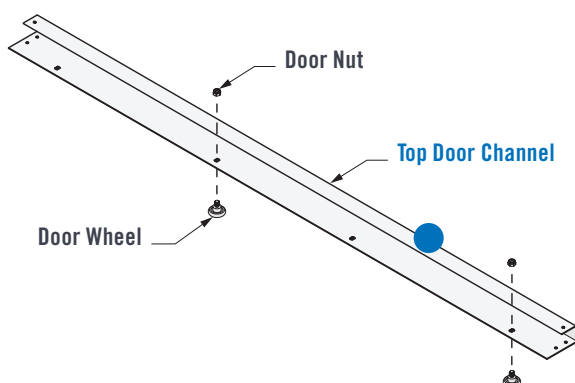

FIGURE 5.1

Fit the two Handle Mounts into the Vertical Door Channel (Figure 5.2). The two Handle Mounts are the same component, so can be installed in either order.

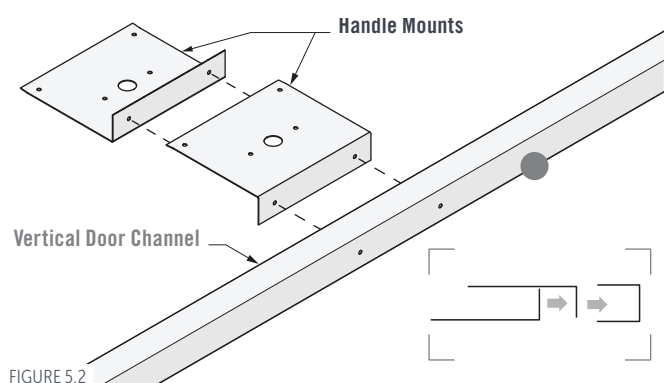

FIGURE 5.2

Fasten two 10x16 Wafer-Head Screws through the Vertical Door Channel and into the Handle Mounts (Figure 5.3).

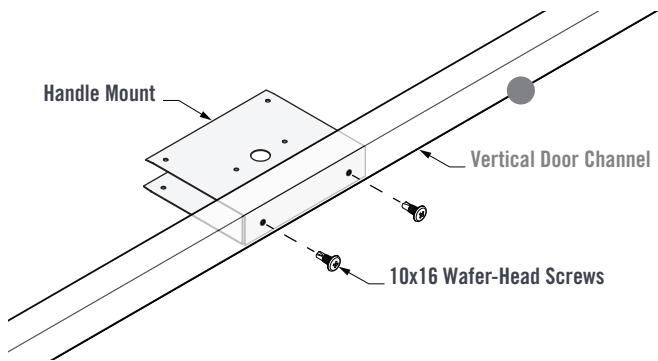

FIGURE 5.3

Using Trestles or Blocks to support the Sheets, lay down the Split Door Sheet and Door Sheet. Pay attention to lapping details (Figure 5.4).

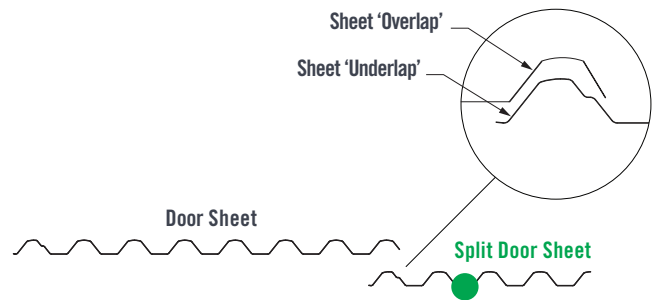

FIGURE 5.4

1. Fit the Vertical Door Channels over the side of the door sheets, then fit the Top and Bottom Door Channels over the door sheet ends. Ensure the lip of the Top and Bottom Door Channels fit over the Vertical Door Channels (Figure 5.5).
2. Fasten one 10x16 Wafer-Head Screw through the pilot holes in the corner of each Top & Bottom Channel and into the Vertical Door Channels (Figure 5.5).
3. Crest-fix two 10x16 Wafer-Head Screws through the pilot holes in the Handle Mount and into the Split Door Sheet (Figure 5.5).

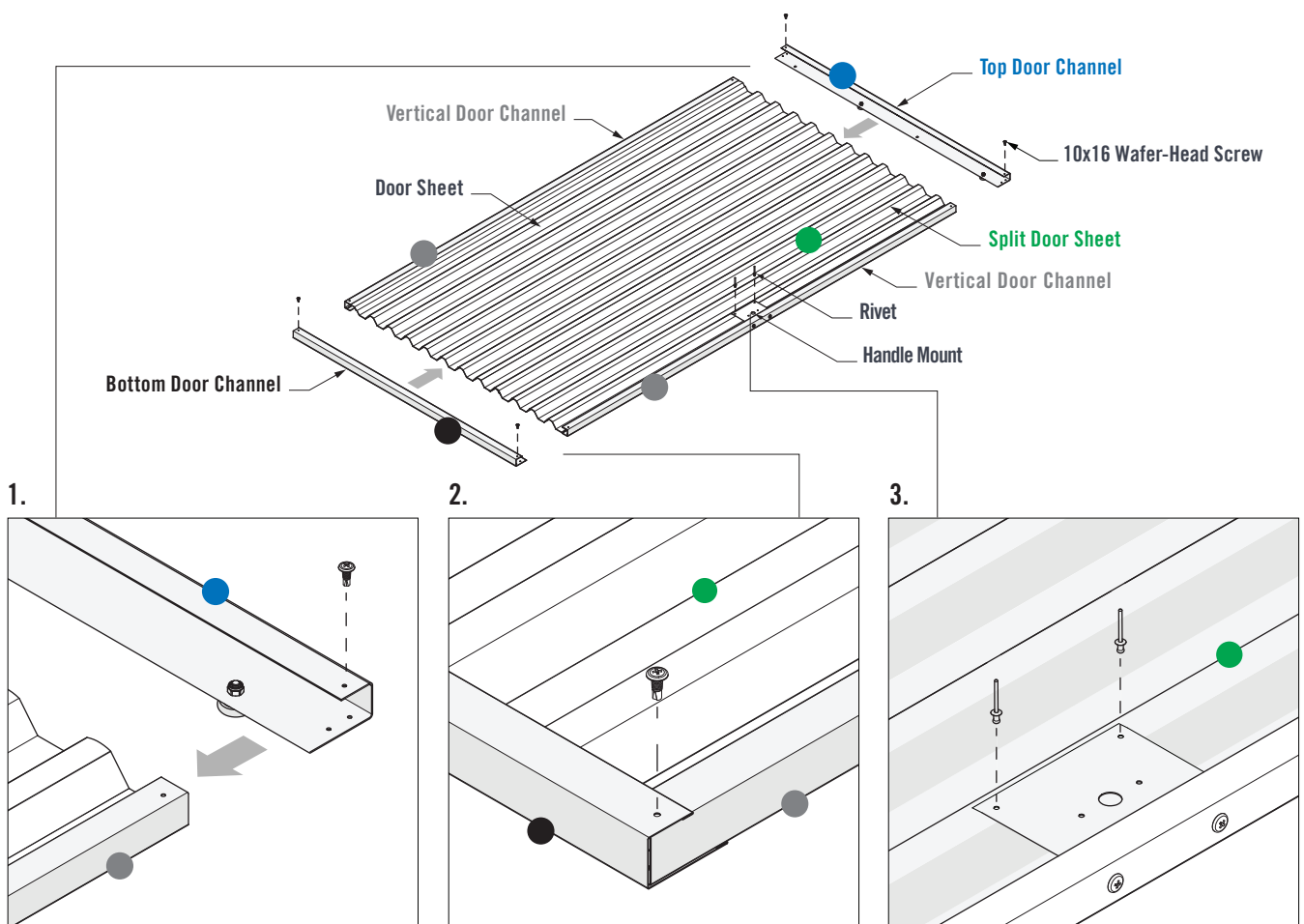

FIGURE 5.5

HANDI-MATE™ OFF THE WALL HM3 SLIDING DOOR SHED INSTALLATION GUIDE

1. Fasten a 10x16 Hex-Head Screw into the mid-point of the Bottom Door Channel. Ensure the screw is fastened approximately 10mm from the bottom face of the Channel. Fasten a 10x16 Hex-Head Screw near the Handle Mount end of the Bottom Door Channel. Flip over the Door Assembly so that the underside is now facing up. Fasten two more 10x16 Hex-Head Screws in the same manner on the opposite side of the Bottom Door Channel (Figure 5.6).
2. Fasten two 10x16 Wafer-Head Screws through pilot holes in the Handle Mount and into the Door Sheet. Using the holes in the Handle Mounts as a guide, drill a $\varnothing 3.5\text{mm}$ pilot hole, then $\varnothing 12\text{mm}$ hole through the Wall Sheet (Figure 5.6).
3. Fasten two 10x16 Wafer-Head Screws through pilot holes in the Top and Bottom Door Channels and into the Vertical Door Channels at all four corners (Figure 5.6).
4. Fasten a 10x16 Wafer-Head Screw through the Top Door Channel and into the two Sheet Crests on both sides of the Door Wheel (Figure 5.6).

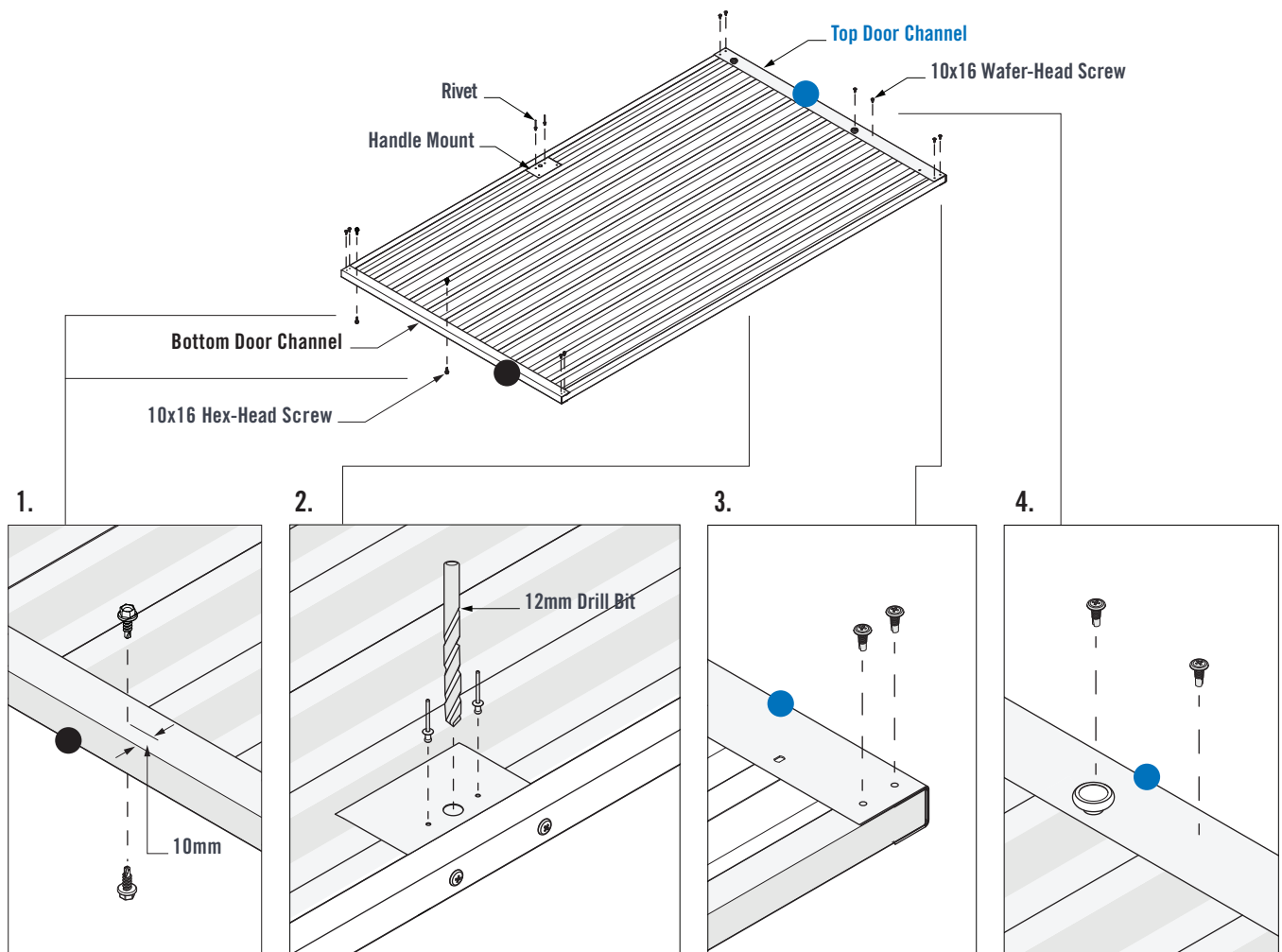

FIGURE 5.6

JOINING WALL ASSEMBLIES

Confirm the location of the Shed against the building wall. Position the Left Side Wall Assembly against the building wall. Use a spirit level to ensure the Wall Assembly is vertical and square to the wall. Note: the Roof Mount Channel can be used to confirm the correct width of the shed (Figure 6.0).

1. Mark and drill three 10mm holes through the pilot holes of the Wall Mount Channel and into the building wall. Loosely install three M10x47 Masonry Anchors (Figure 6.0).
2. Before tightening the Masonry Anchors, apply a bead of silicone between the Wall Mount Channel and building wall to prevent rain entering the shed (Figure 6.0).

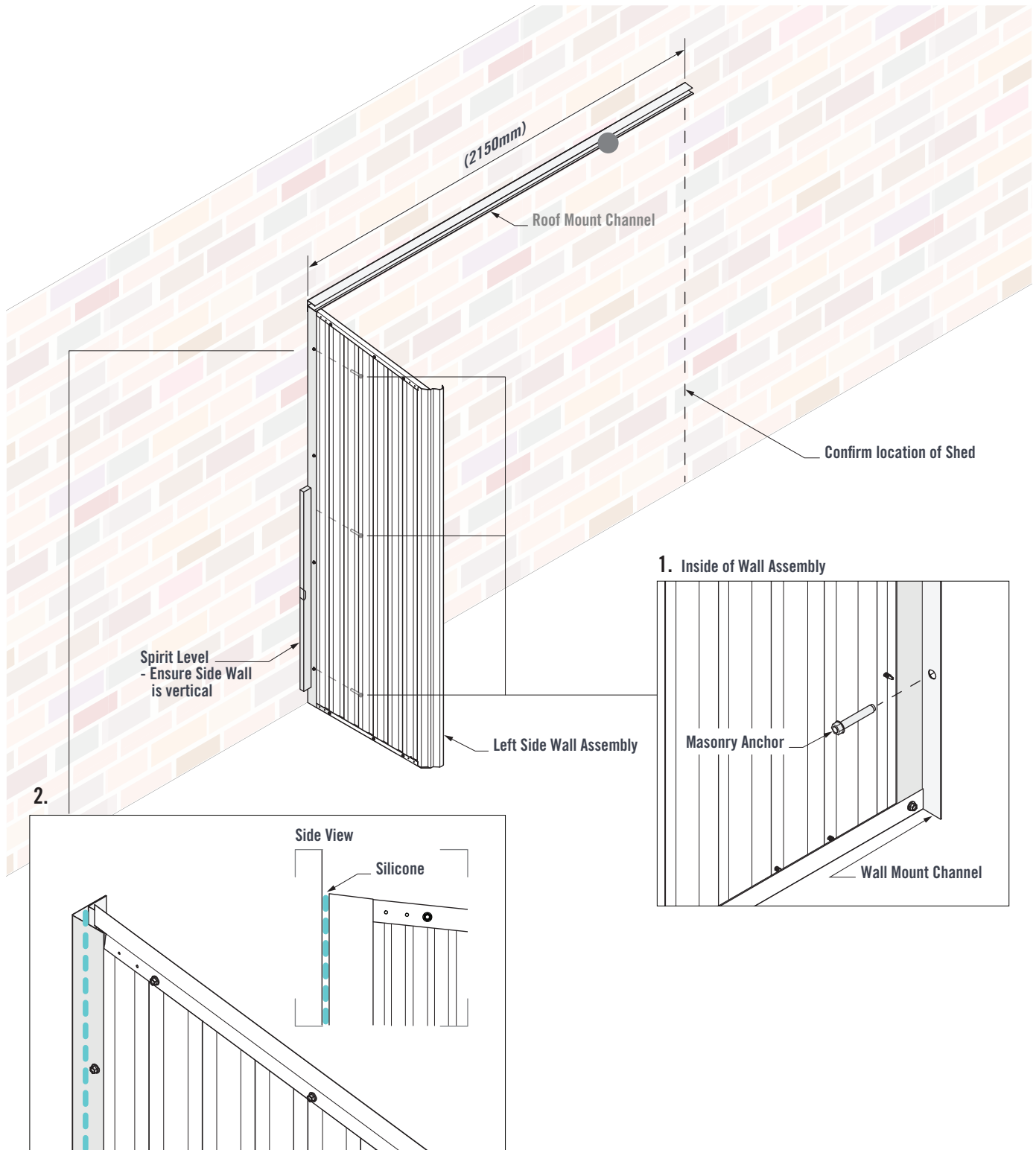

FIGURE 6.0

HANDI-MATE™ OFF THE WALL HM3 SLIDING DOOR SHED INSTALLATION GUIDE

Position the Right Side Wall Assembly against the building wall. Use a spirit level to ensure the Wall Assembly is vertical and square to the wall. Use the Roof Mount Channel to set the correct spacing between Side Wall Assemblies (Figure 6.1).

1. Mark and drill three 10mm holes through the pilot holes of the Wall Mount Channel and into the building wall. Loosely install three M10x47 Masonry Anchors (Figure 6.1).

2. Before tightening the Masonry Anchors, apply a bead of silicone between the Wall Mount Channel and building wall to prevent rain entering the shed (Figure 6.1).

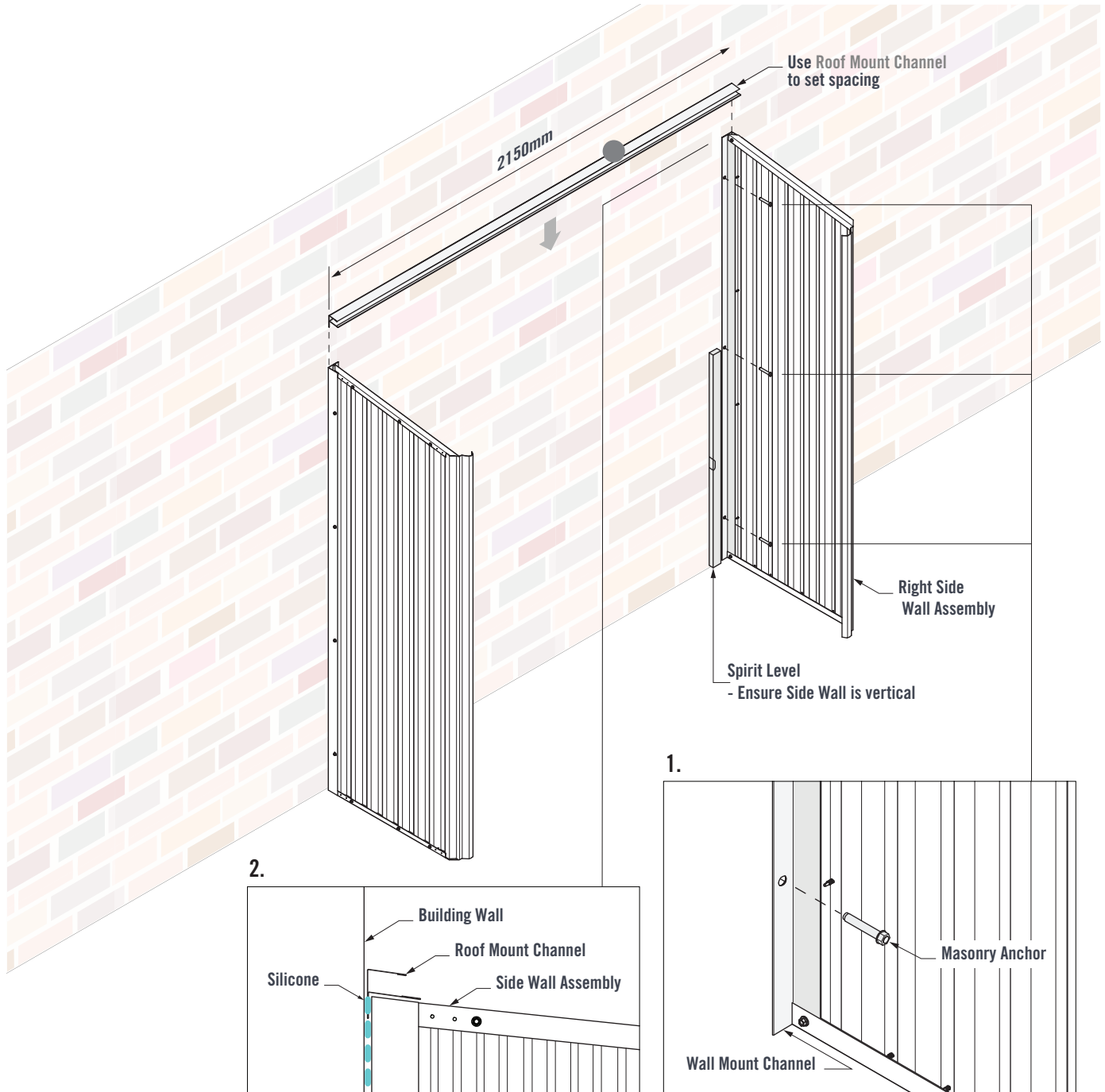

FIGURE 6.1

1. Ensure both ends of the Roof Mount Channel are in-line with the Wall Mount Channels. Mark and drill three 10mm holes through the pilot holes of the Roof Mount Channel and into the building wall. Loosely install three M10x47 Masonry Anchors (Figure 6.2).
2. Before tightening the Masonry Anchors, apply a bead of silicone between the Roof Mount Channel and building wall to prevent rain entering the shed (Figure 6.2).

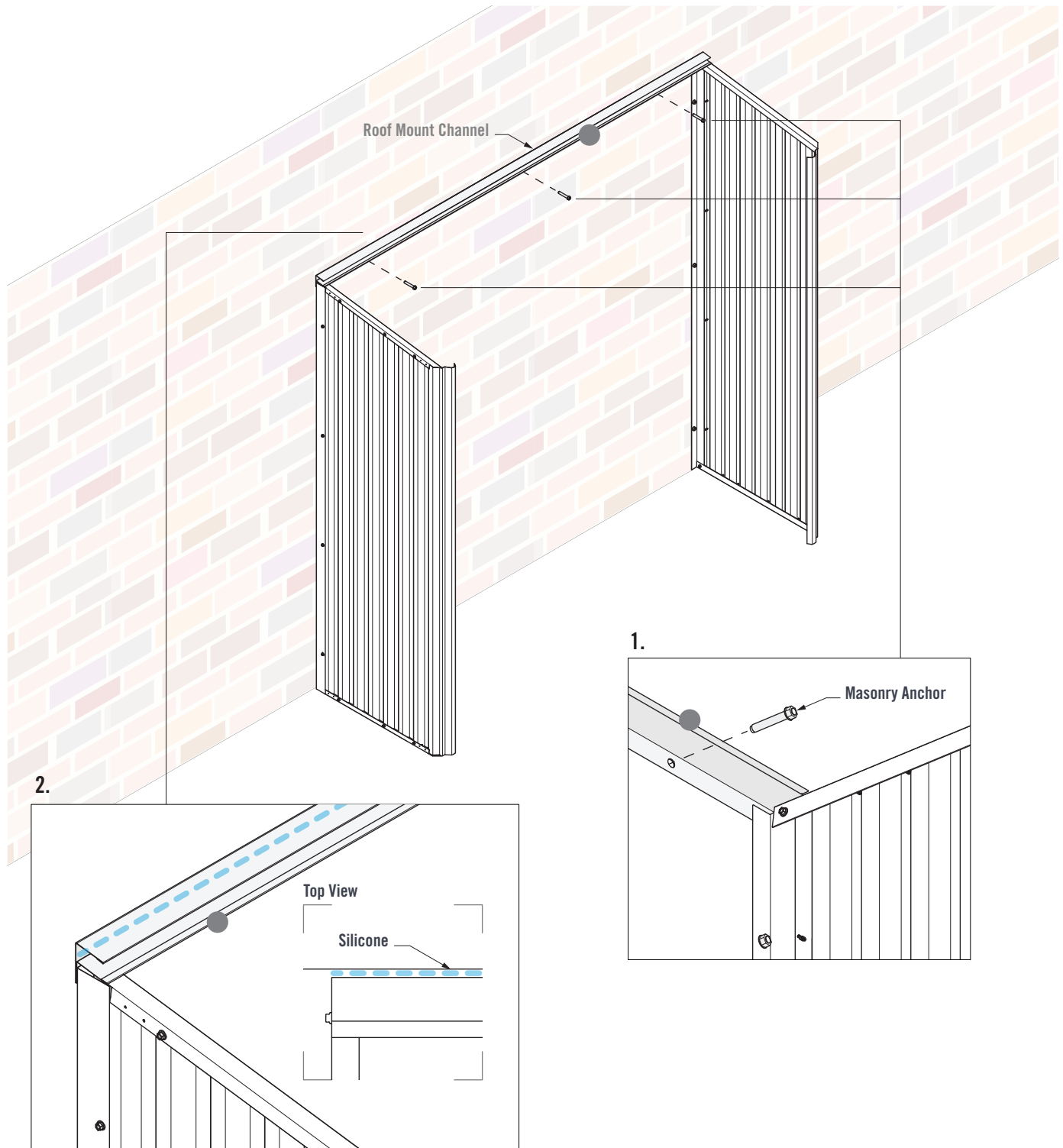

FIGURE 6.2

JOINING WALL ASSEMBLIES

Fit the Corner Wall Sheet of the Front Wall Assembly over the Left Side Wall Sheet. Ensure the Corner Sheet fits inside the Side Wall Channels (Figure 7.0).

1. Fit a Corner Bracket over the top Channels. Ensure the pilot holes of the Corner Bracket and Channels line up (Figure 7.0).
2. Fasten through the Corner Bracket pilot holes and into the top Channels using four 10x16 Hex-Head Screws (Figure 7.0).
3. Fit a Corner Bracket to the bottom Wall Channels. Fasten through the Corner Bracket pilot holes and into the bottom Wall Channels using four 10x16 Hex-Head Screws (Figure 7.0).

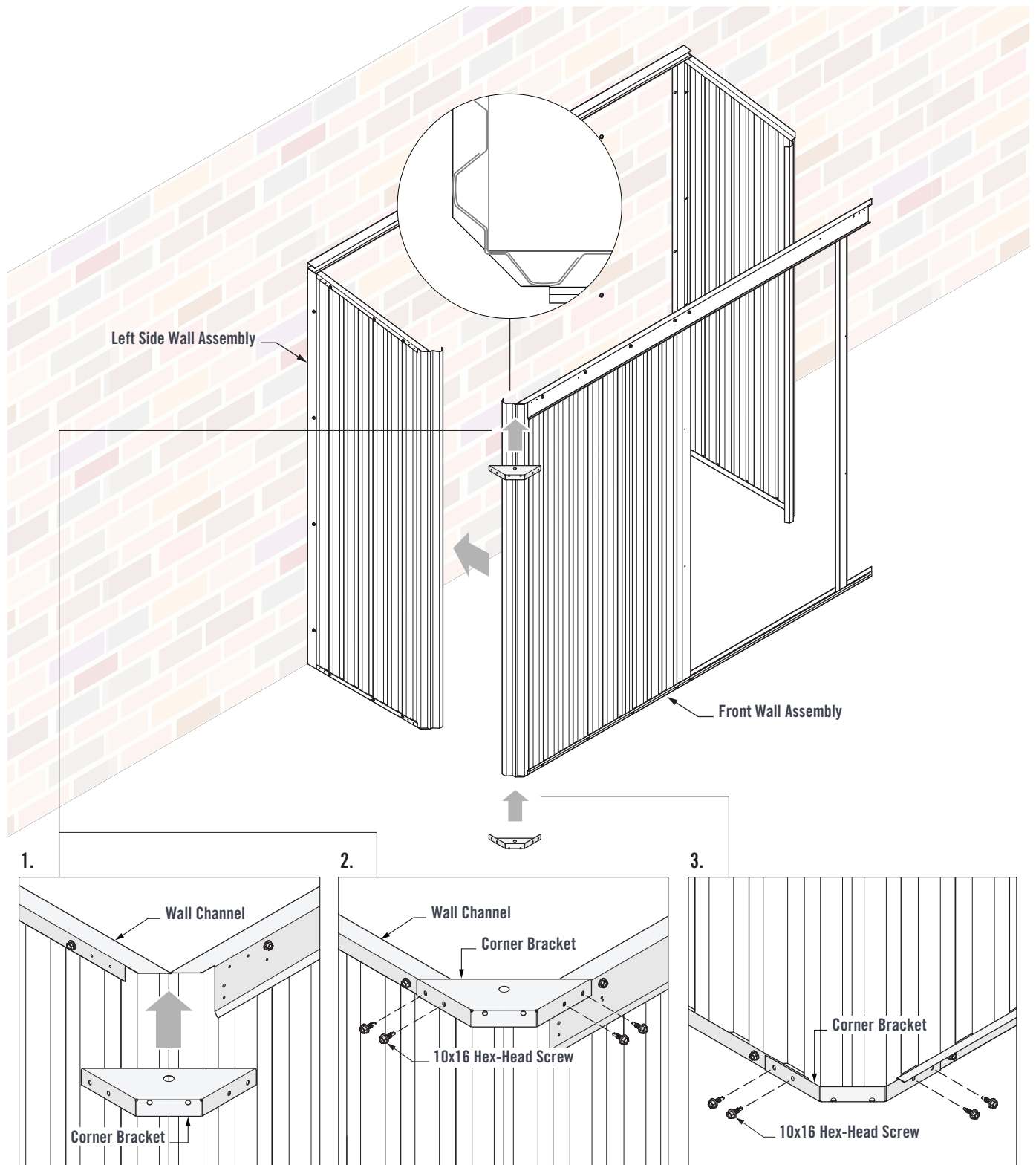

FIGURE 7.0

Fit the Front Wall Assembly over the Right Side Wall Sheet. Ensure the Right Side Wall Sheet fits into the **Sliding Rail** and **Bottom Channel** (Figure 7.1).

1. Fit the **Door Jamb** over the corner of the Right Side Wall Sheet (Figure 7.1).
2. Fit the Corner Brackets as per Figure 7.0.

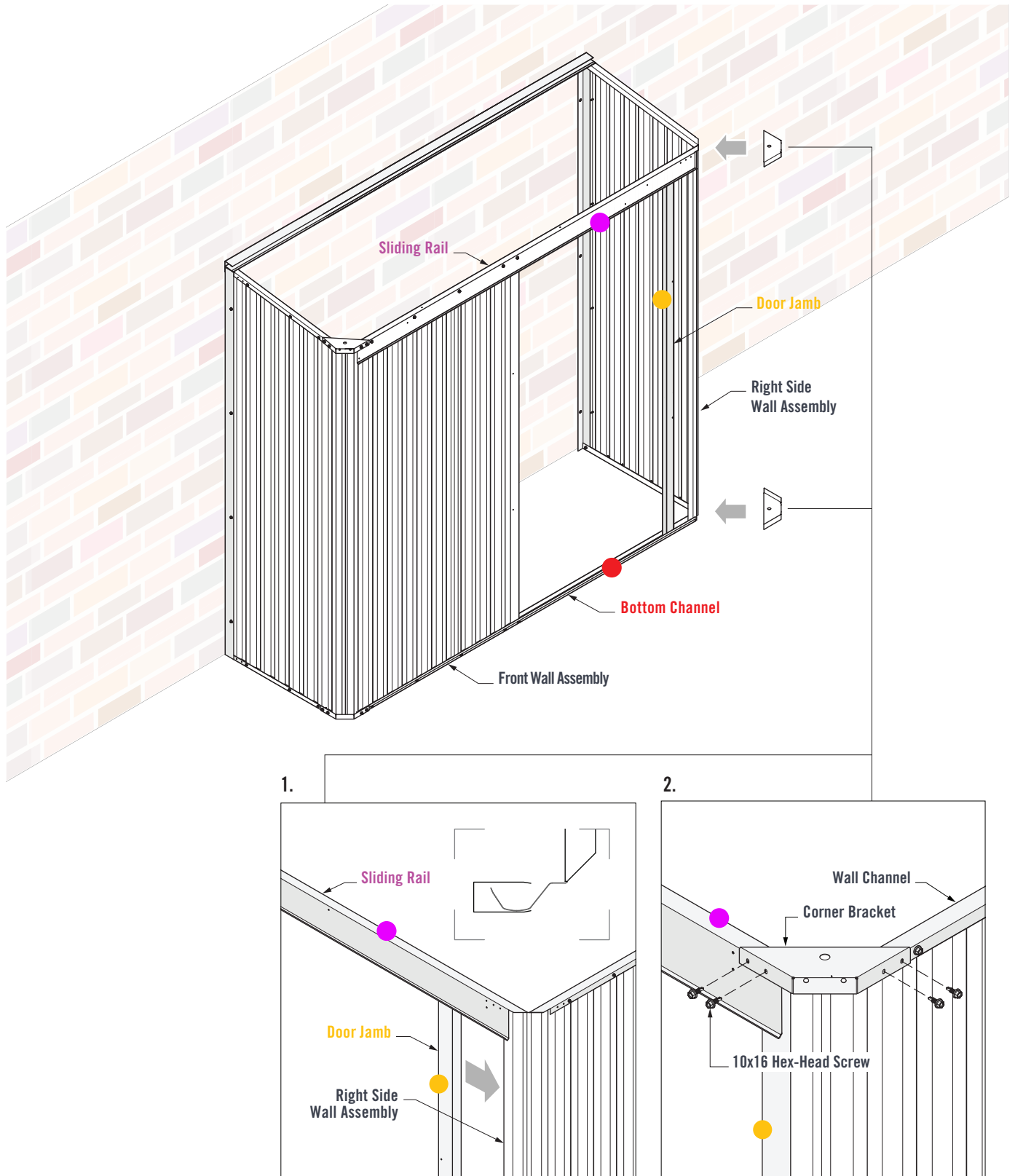

FIGURE 7.1

HANDI-MATE™ OFF THE WALL HM3 SLIDING DOOR SHED INSTALLATION GUIDE

1. Fasten a 10x16 Hex-Head Screw through the pilot hole of the **Sliding Rail** (Figure 7.2).
2. Fasten three 10x16 Hex-Head Screws through the pilot holes of the **Sliding Rail** (Figure 7.2).
3. Fasten two 10x16 Hex-Head Screws through the pilot holes of both **Door Jambs** and into the Wall Sheets (Figure 7.2).

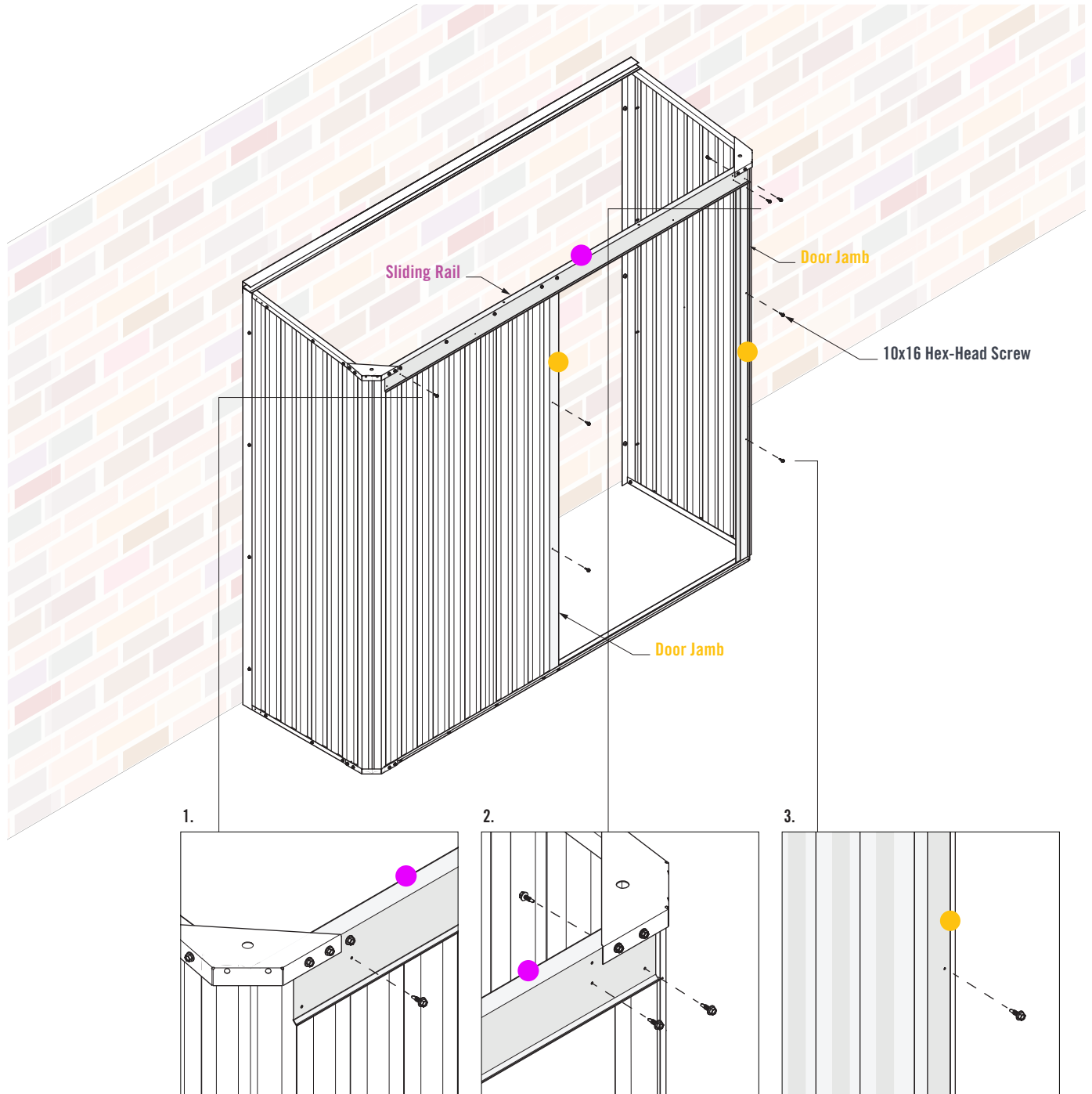

FIGURE 7.2

1. Fit the Gutter over the **Sliding Rail**. Fasten two 10x16 Wafer-Head Screws through the pilot holes of the Gutter and into the **Sliding Rail** (Figure 7.3).
2. Fit the Runner Rail over the **Bottom Channel**. Ensure the end of the Runner Rail is in line with the edge of the Corner Bracket. Fasten four 10x16 Hex-Head Screws through pilot holes in the Runner Rail and into the **Bottom Channel** (Figure 7.3).

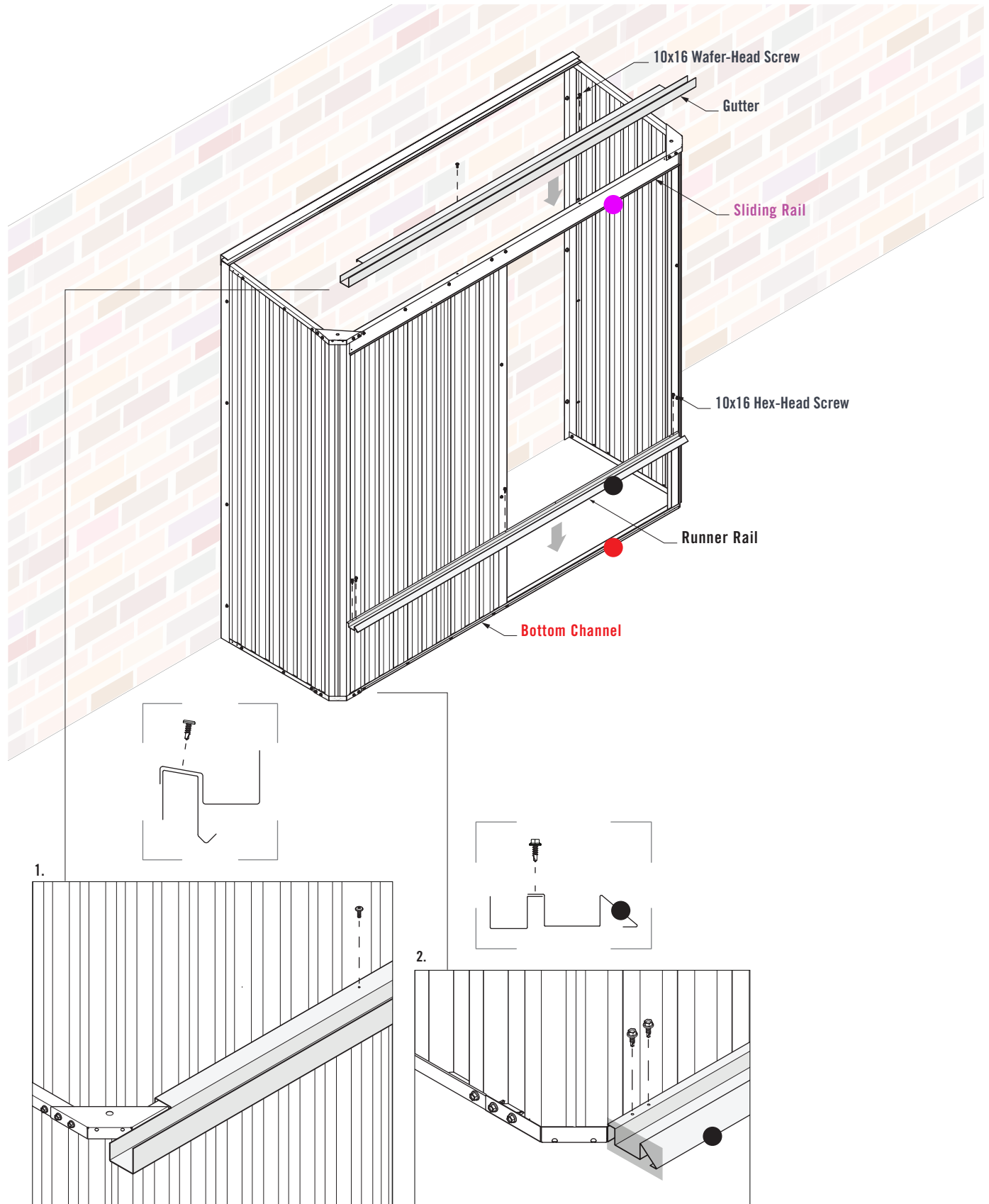

FIGURE 7.3

HANDI-MATE™ OFF THE WALL HM3 SLIDING DOOR SHED INSTALLATION GUIDE

1. Slide the Door into the **Sliding Rail** and Runner Rail. The Door Roller fits into the **Sliding Rail** at the top. The bottom of the Door fits into the Runner Rail at the bottom (Figure 7.4).

1. Fasten a 10x22 Wafer-Head screw through the Door Stop and into the pilot hole in the **Sliding Rail** (Figure 7.4).

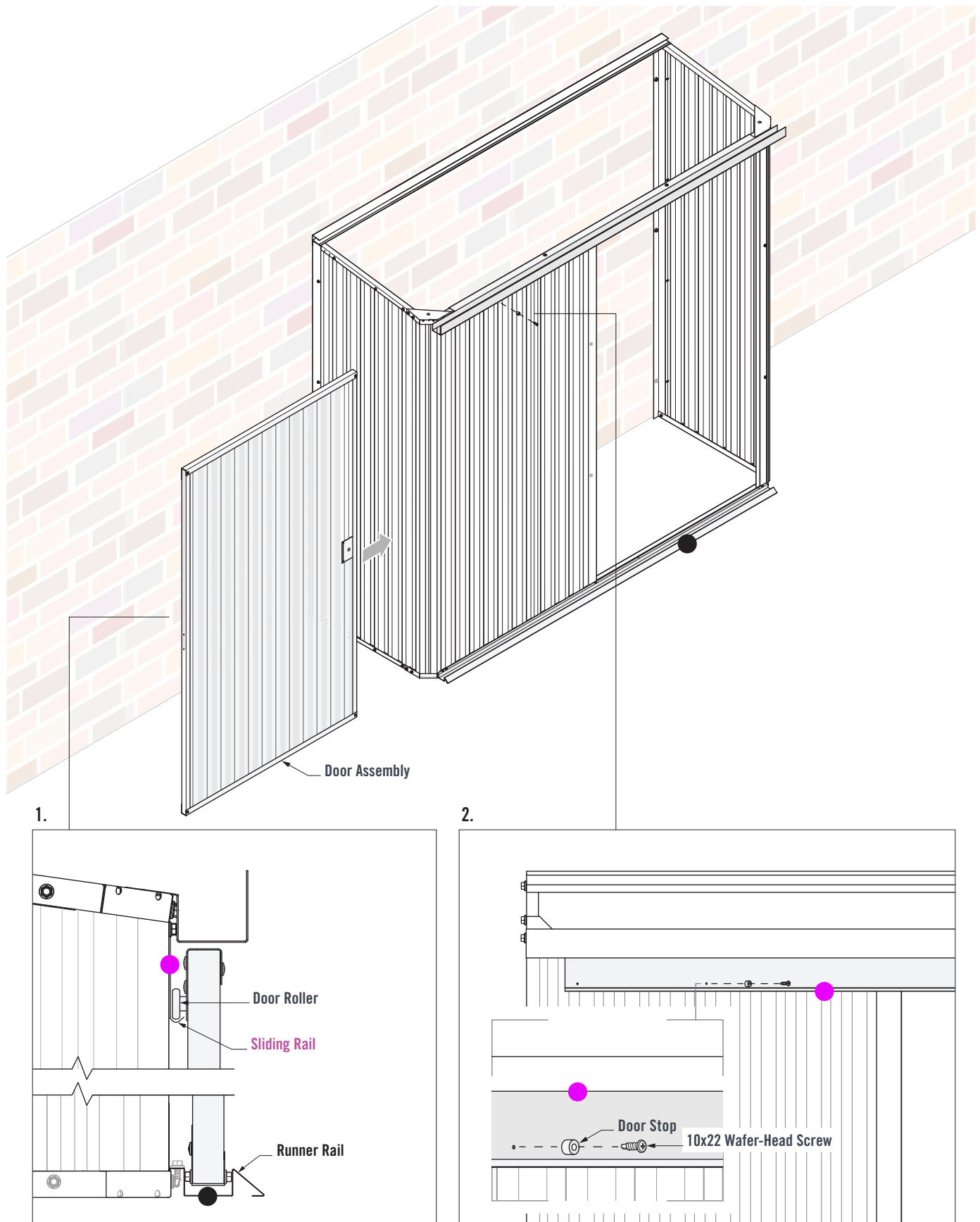

FIGURE 7.4

Check the walls are square. Check the diagonal measurements from corner to corner (dashed lines, Figure 7.5). The diagonal measurements should be equal for the walls to be square.

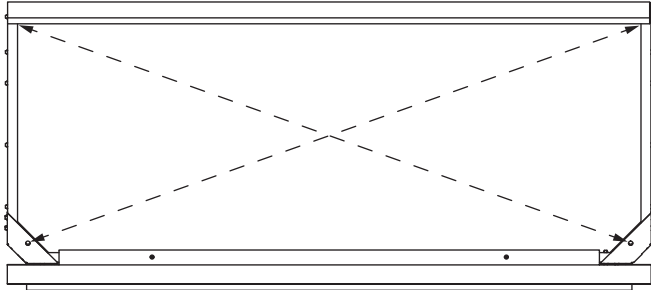

FIGURE 7.5

Note: Shed anchoring requirements are determined by the wind zone the Handi-Mate is installed in. Contact a Stratco store for further information or to determine your wind zone.

The recommended anchor spacing in Figure 7.6 below, where anchor points are no greater than 900mm apart (excluding door opening), will satisfy engineering requirements for N1, N2 and N3 wind zones.

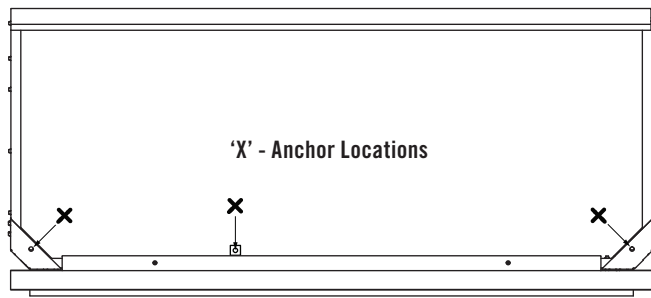

FIGURE 7.6

Using the Corner Bracket pilot holes as a guide, drill holes in both corners with a 10mm masonry drill bit. Secure both bottom Corner Brackets to the concrete base with M8x47 Masonry Anchors (Figure 7.7).

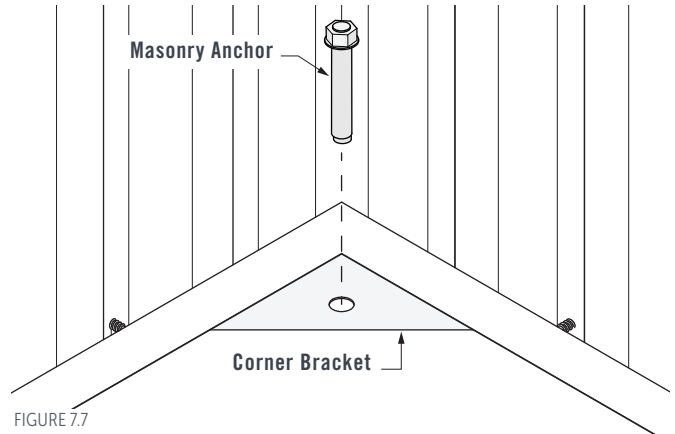

FIGURE 7.7

Fit a Hold Down Lug to the **Bottom Channel**, offset from the door opening. Fasten a 10x16 Hex-Head Screw through the Hold Down Lug and into the **Bottom Channel** and Wall Sheet. Fix the Hold Down Lug to the concrete base with an M8x47 Masonry Anchor (Figure 7.8).

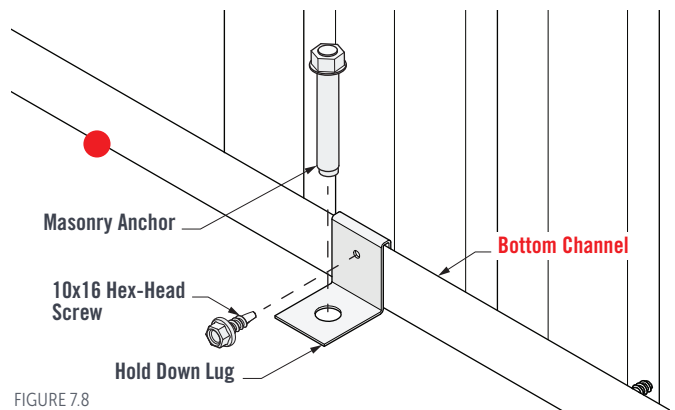

FIGURE 7.8

ROOF ASSEMBLY

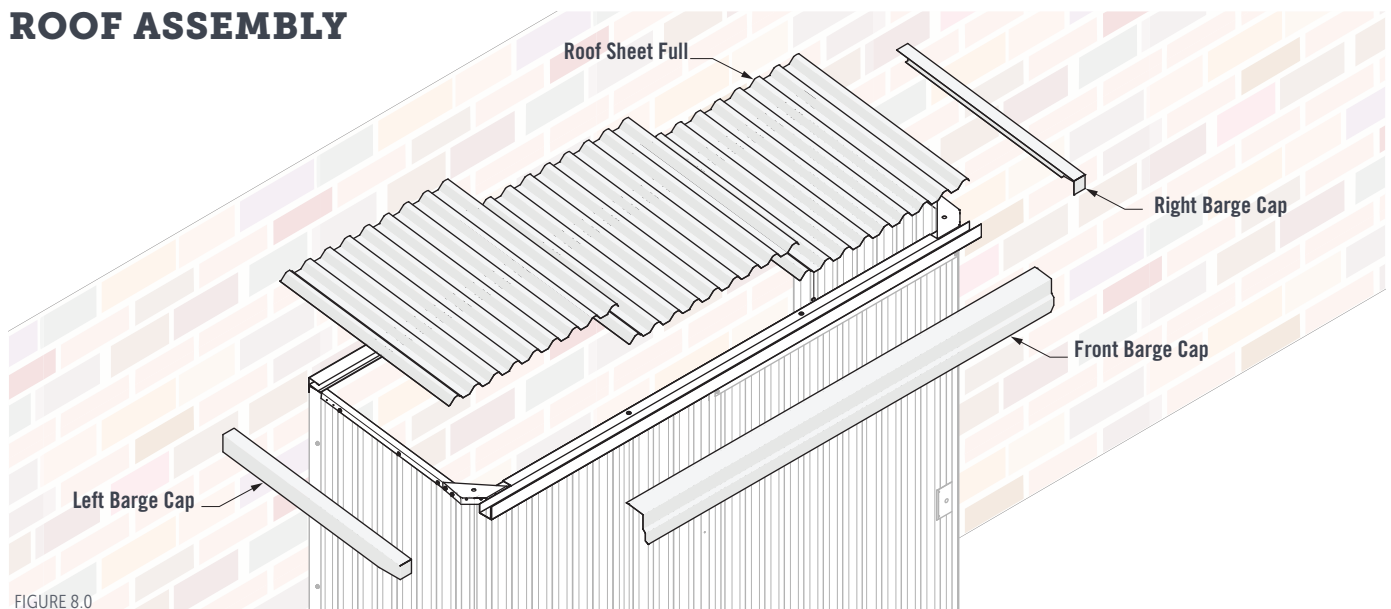

FIGURE 8.0

HANDI-MATE™ OFF THE WALL HM3 SLIDING DOOR SHED INSTALLATION GUIDE

Use an adjustable spanner to turn up the pans at the Roof Mount Channel end of the Roof Sheets. This will prevent water flowing back under the sheet (Figure 8.1).

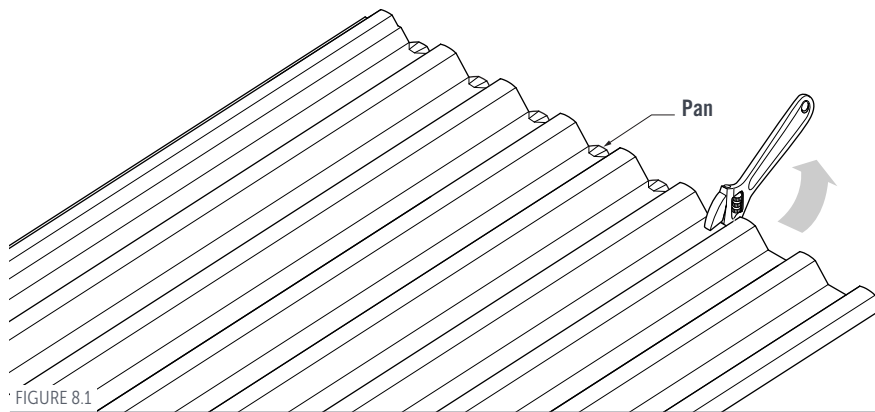

FIGURE 8.1

1. Fit the Roof Sheets into the Roof Mount Channel. Fasten eleven Coloured 10x16 Hex-Head Screws with Neo Washers through the Roof Mount Channel and into every second Roof Sheet crest (Figure 8.2).
2. Fasten fifteen Coloured 10x16 Hex-Head Screws with Neo Washers through every second Roof Sheet pan and into the Gutter. Ensure a Screw is fastened in both pans either side of the sheet laps (Figure 8.2).

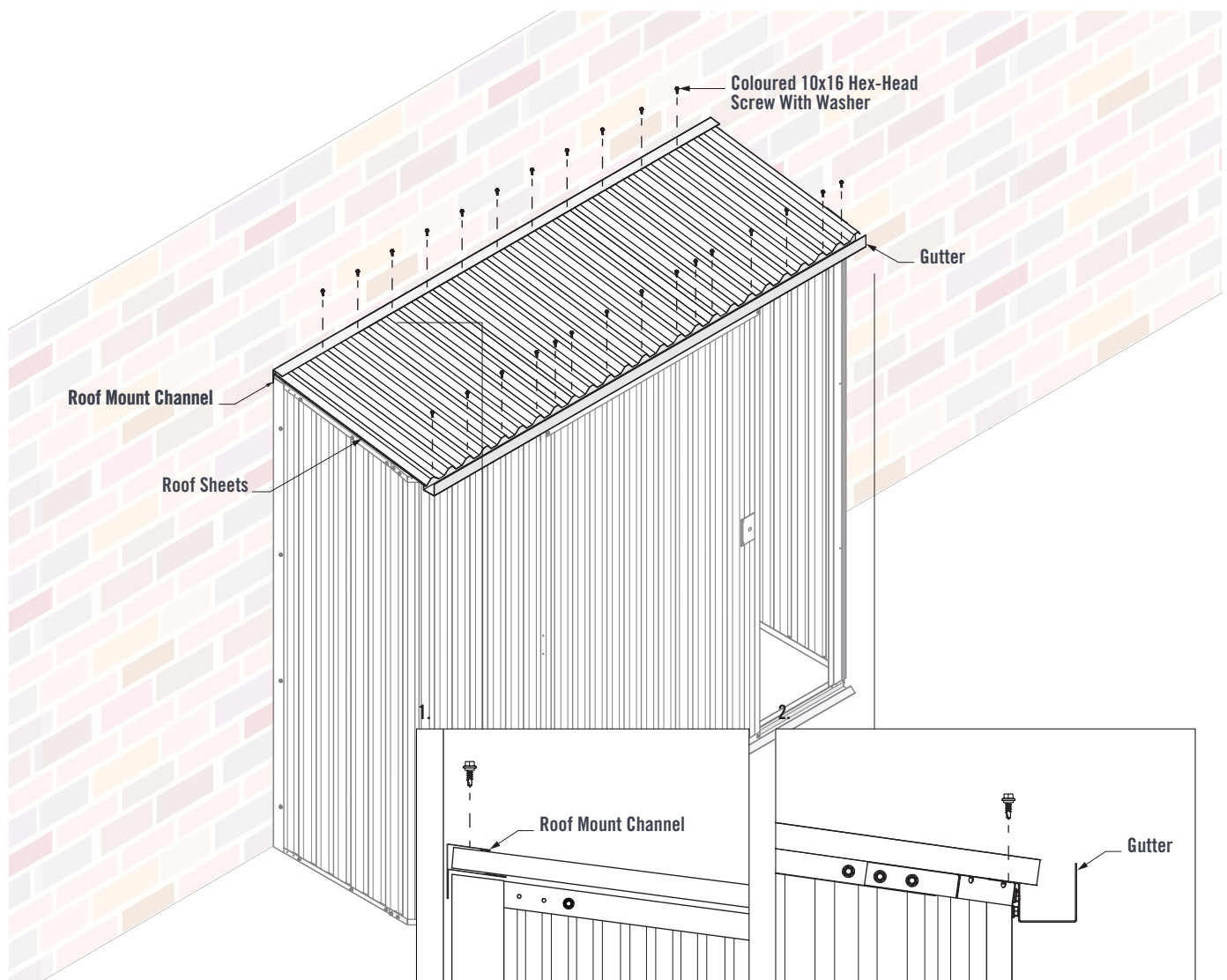

FIGURE 8.2

1. Fit the Front Barge Cap against the Gutter. Ensure a 10mm gap between the end of the Gutter and end of the Front Barge Cap (Figure 8.3).
2. Fasten two Coloured 10x16 Hex-Head Screws with Washers through the Front Barge Cap and into the Roof Sheet pans (Figure 8.3).

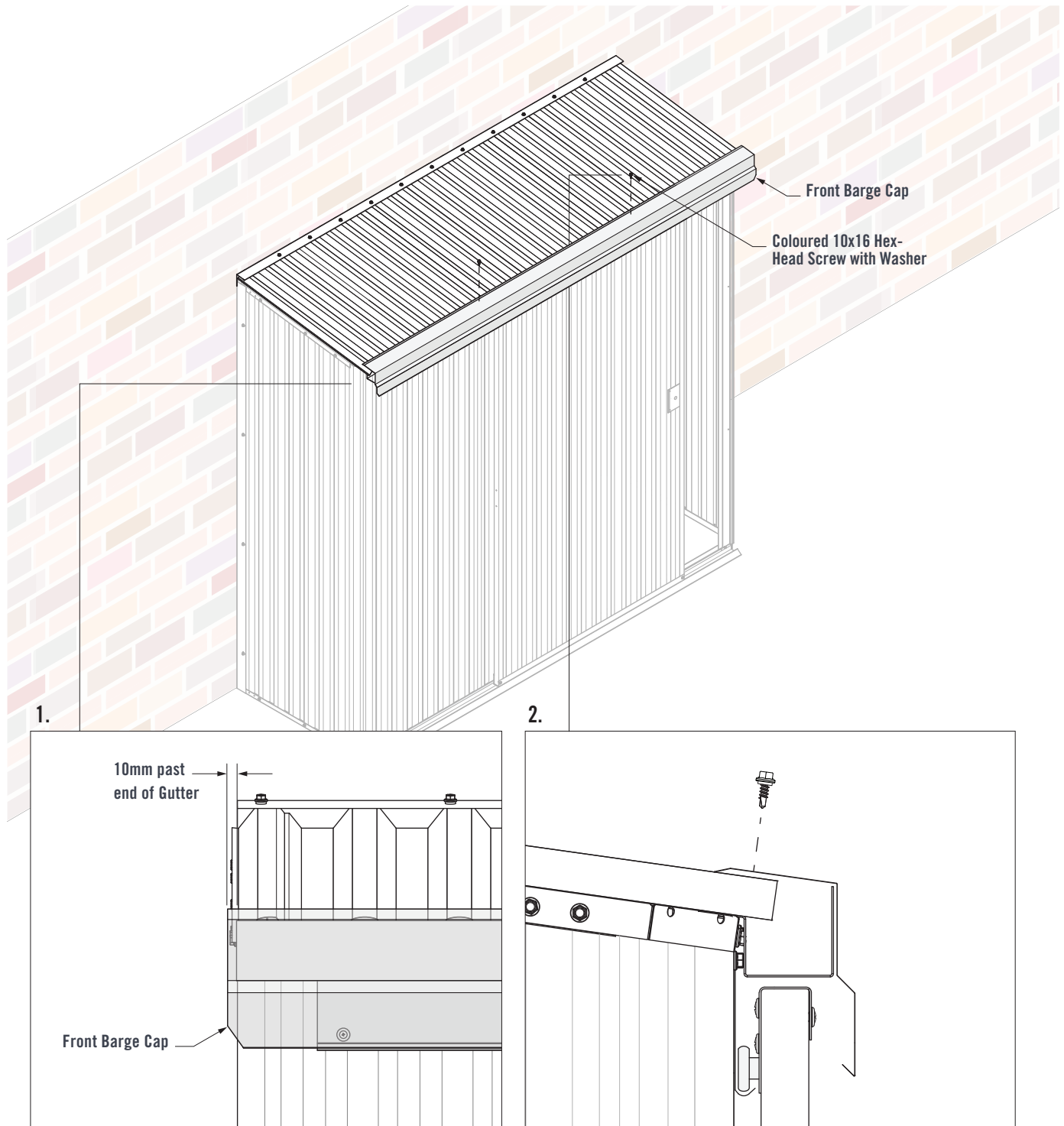

FIGURE 8.3

HANDI-MATE™ OFF THE WALL HM3 SLIDING DOOR SHED INSTALLATION GUIDE

1. Place the Left Barge Cap over the Roof Sheet at the left of the shed. Ensuring the Left Barge Cap is against the Wall and Roof Mount Channel. Ensure the Left Barge Cap is positioned behind the Front Barge Cap (Figure 8.4).
 2. Fasten a Coloured 10x16 Hex-Head Screw with Washer through the Left Barge Cap and into the Roof Mount Channel. Fasten a Coloured 10x16 Hex-Head Screw with Washer through the centre of the Left Barge Cap and into the Roof Sheet (Figure 8.4).
 3. Fasten two Coloured 10x16 Hex-Head Screws with Washers through the Front Barge Cap and into the Left Barge Cap and Gutter (Figure 8.4).
- Fasten the Right Barge Cap in the same manner.

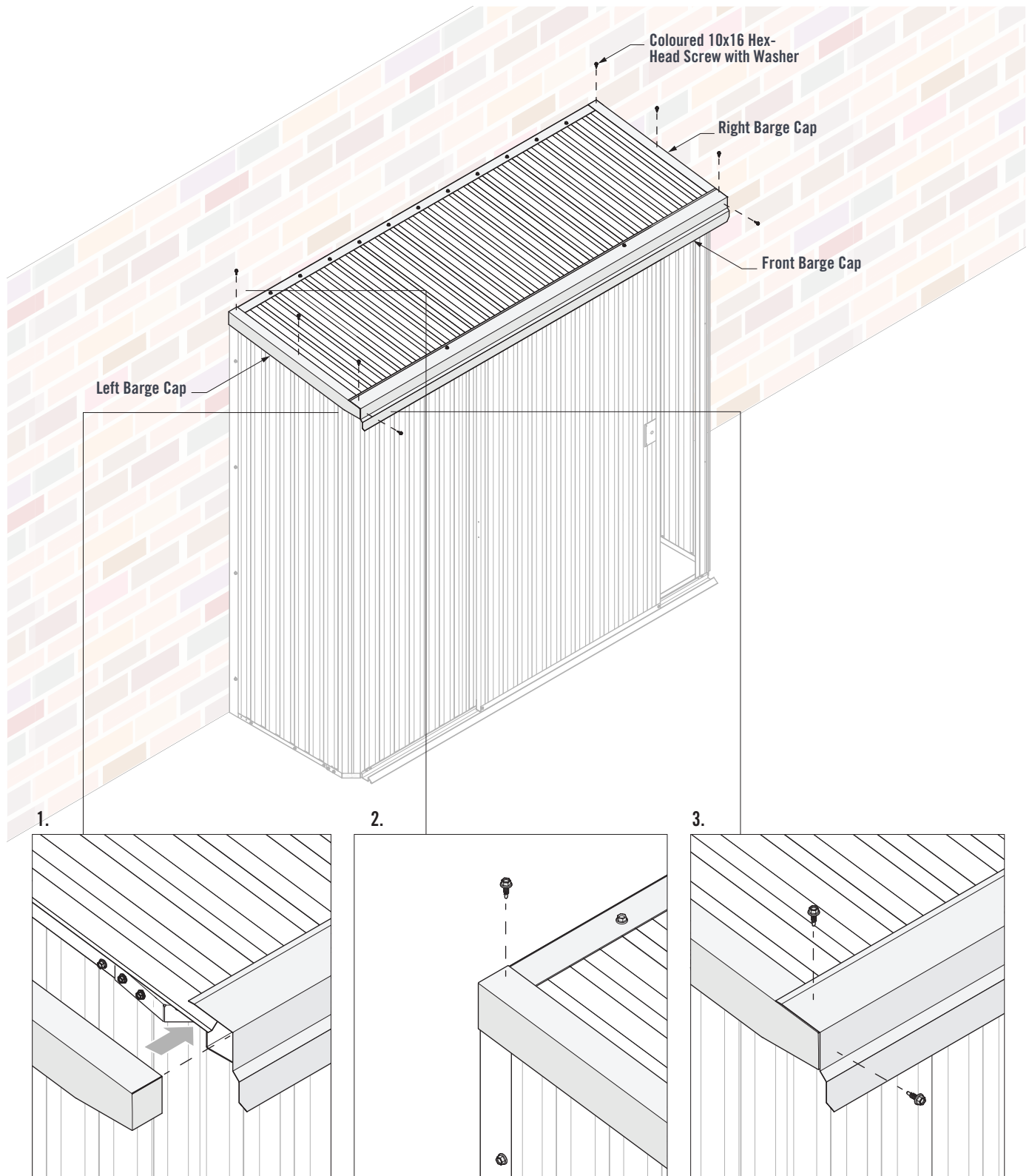

FIGURE 8.4

Fasten the Door Handle to the Handle Mount with two 10x16 Wafer-Head Screws (Figure 8.5).

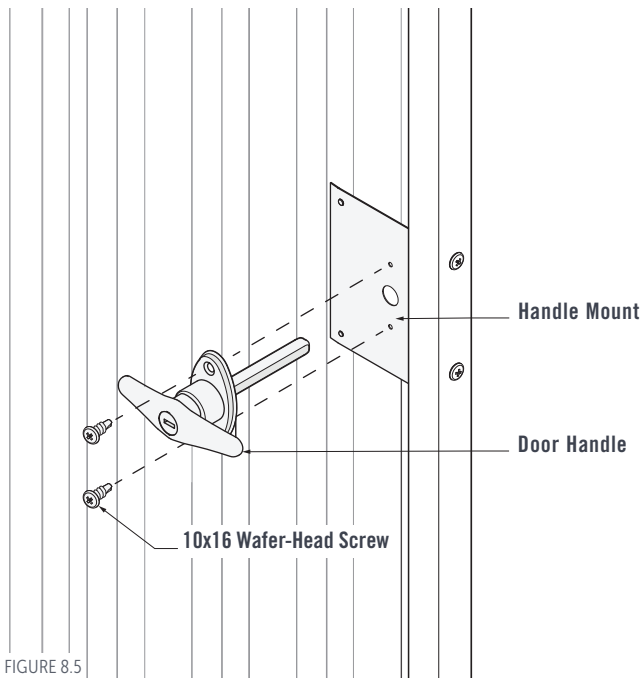

FIGURE 8.5

Slide the Locking Washer onto the Door Handle shaft and up against the Handle Mount. Fit the Door Tongue over the Door Handle shaft. Ensure the Door Tongue is oriented vertically and the Handle is oriented horizontally. Position the Door Tongue approximately 25mm from the Door. Tighten the Door Tongue screw on the Door Handle shaft to secure the Door Tongue in place (Figure 8.6).

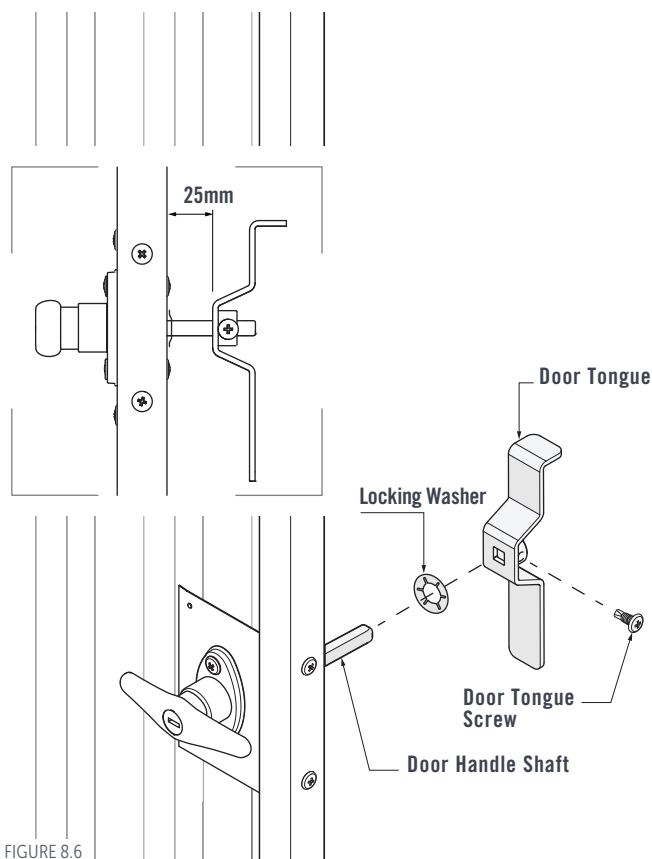

FIGURE 8.6

Close the Door and rotate the handle so that the Door Tongue is horizontal. Using the Door Tongue as a guide, fasten the Door Latch to the Door Jamb with two 10x16 Wafer-Head Screws (Figure 8.7).

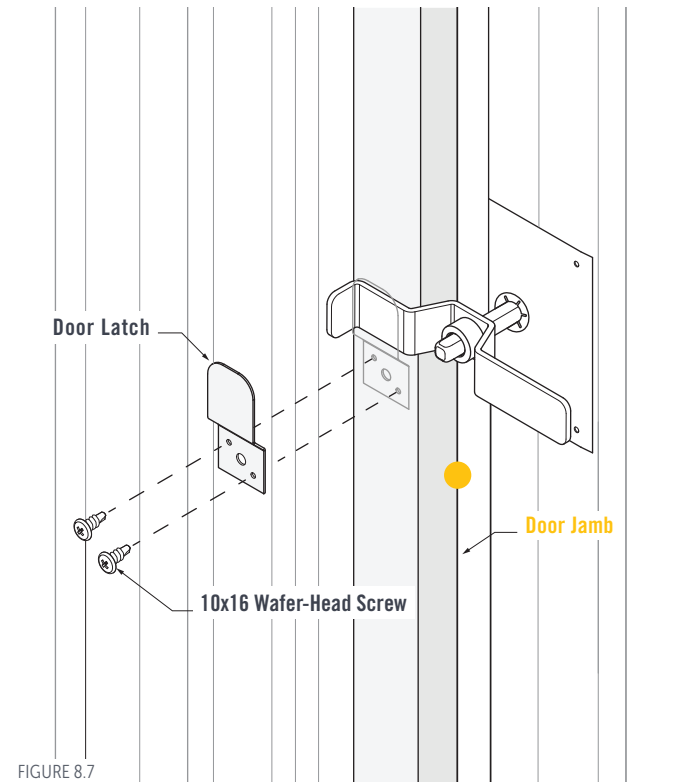

FIGURE 8.7

Fasten the Door Shroud to the Runner Rail with four 10x16 Hex-Head Screws (Figure 8.8).

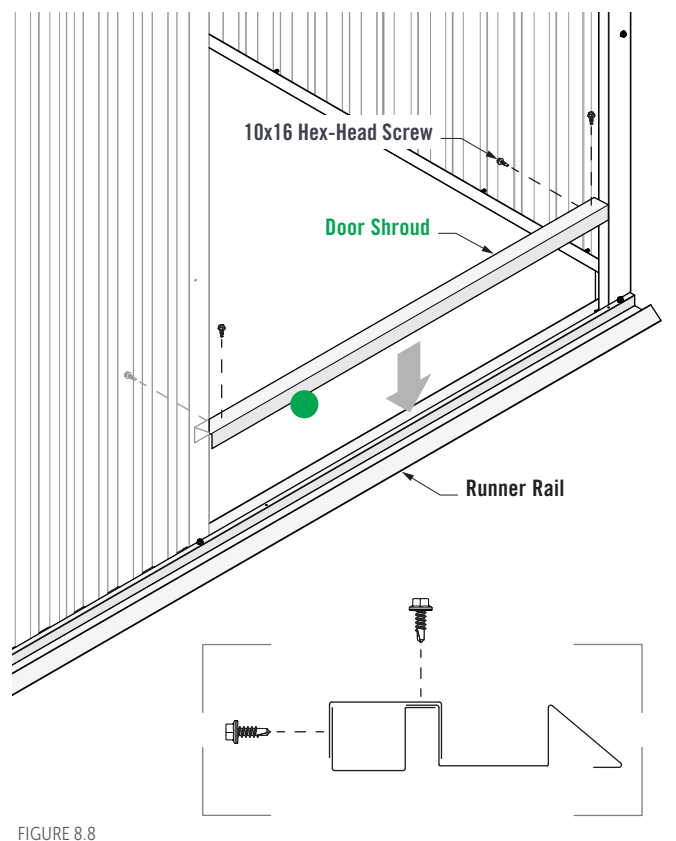

FIGURE 8.8

HANDI-MATE™ OFF THE WALL HM3 SLIDING DOOR SHED INSTALLATION GUIDE

A coloured Rivet should be installed at sheet laps in the wall corner and door. Drill a 3.5mm hole through the centre of each sheet lap and install a coloured Rivet (Figure 8.9).

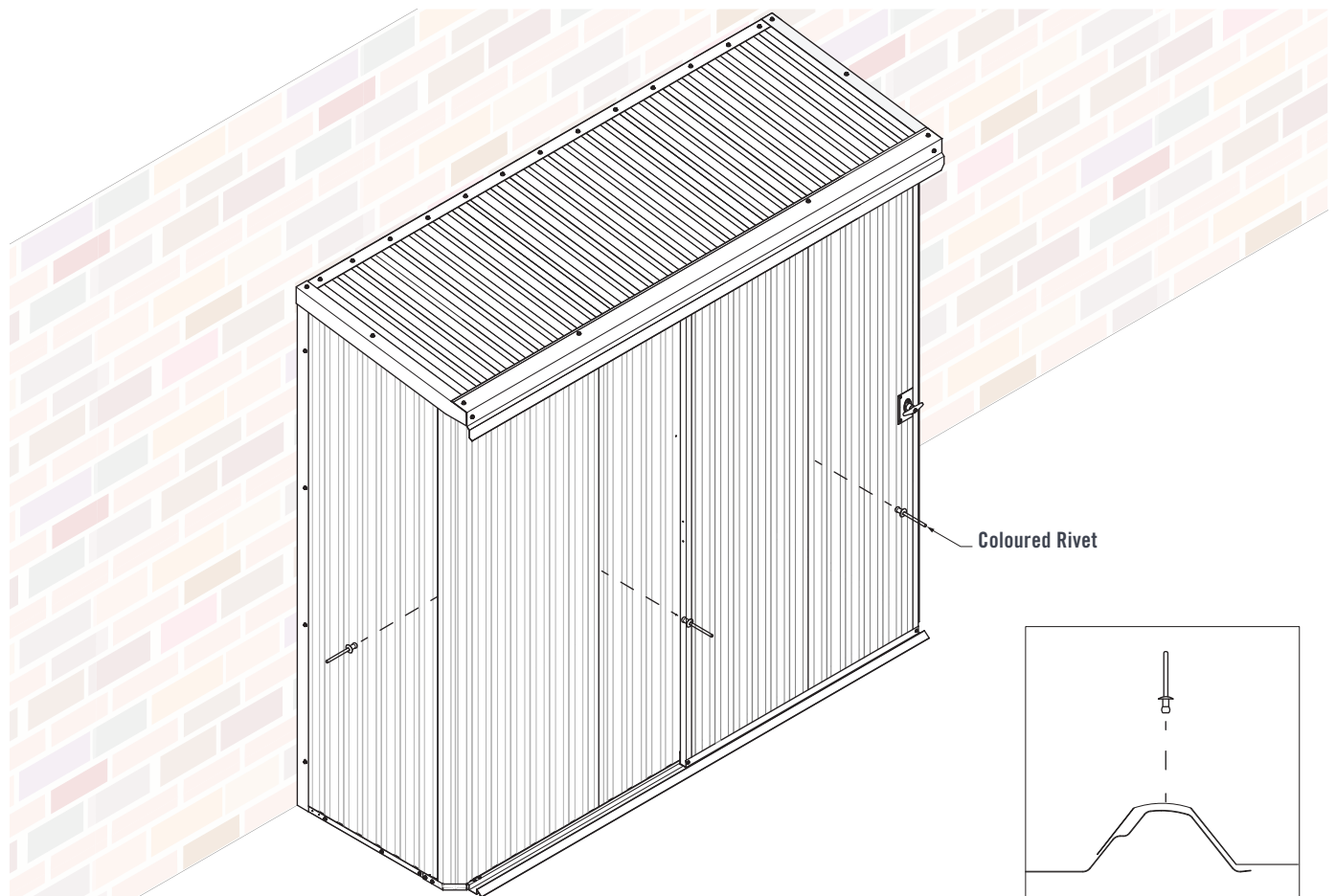

FIGURE 8.9

Water-Proofing the Floor (Optional)

Water may enter the Shed between the bottom Wall Channels and Floor. Water ingress can be mitigated by applying silicone to the gaps along the Floor. From the inside of the Shed, apply a bead of silicone along the entire perimeter of the Shed, including along the Corner Brackets and Wall Channel ends. Do not apply silicone to the outside of the Shed as this will not allow water to flow out and away from the Shed (Figure 8.11).

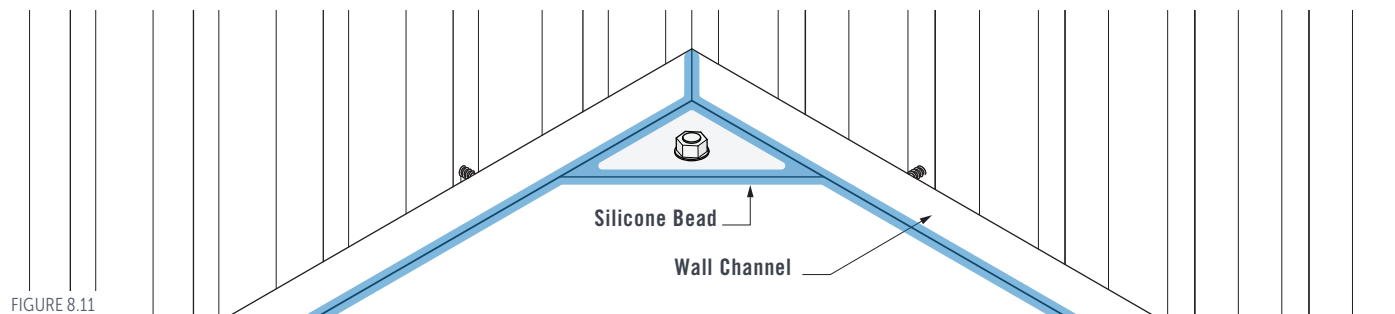











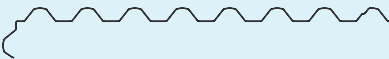

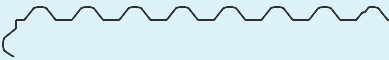











FIGURE 8.11

SHED MAINTENANCE











It is vital that all metal swarf and filings are removed from the shed as to prevent rust spots from forming. Your Stratco Handi-Mate™ Shed will maintain its good looks for even longer with a simple wash and wipe down. Cleaning should be performed as often as is required to remove any dirt, salt and pollutants.

Stratco Handi-Mate™ Sheds are produced from the highest quality materials and will provide many years of service. Refer to the 'Selection Use and Maintenance' brochure for more information on how to get the best out of your product.

COMPONENT INDEX

PROFILE	DESCRIPTION	PRODUCT CODE
	Runner Rail	HMRRBO2047GA
	Sliding Rail	PM-12610-GA
	Gutter	PM-12615-2155-GA
	Barge Cap - Left Hand Side	PM-12613-AZ
	Barge Cap - Right Hand Side	PM-12614-AZ
	Front Barge Cap	PM-12612-2165-AZ
	Roof Mount Channel	PM-12606-2150-AZ
	Wall Mount Channel	PM-12607-AZ
	Roof Sheet	PM-12604-AZ
	Split Door Sheet	SSPHMSD1900AZ
	Corner Wall Sheet	SSPHMWSCNR1950AZ
	Side Wall Sheet (Left)	PM-12602-AZ
	Side Wall Sheet (Right)	PM-12603-AZ
	Door Sheet	SSPHMWS1900AZ
	Hold Down Lug	HMHL
	Door Wheel	HMDW
	Door Stop	HMSS
	Door Nut	HMNN6
	Masonry Anchor	MAA847
	Rivet	RIV4-3
	10x16mm Wafer-Head Screw	WTK1016
	10x22mm Wafer-Head Screw	WTK1022
	10x16mm Hex-Head Screw	TEKNNW1016
	Coloured 10x16mm Hex-Head Screw with Neo Washer	TEK1016##

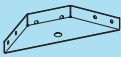

	Door Jamb	PM-12608-AZ
	Door Shroud	HMDSBO1010GA
	Top Door Channel	HMDCTO
	Bottom Door Channel	HMDCBO
	Vertical Door Channel	HMDCVE
	Wall Channel	HMWC700GA
	Bottom Channel	HMBR2100GA
	Door Handle	HMTH
	Door Tongue	HMDT
	Door Latch	HMDL
	Handle Mount	HMDM
	Corner Bracket	HMCB

